



NIPPON OIL CORPORATION
CSR REPORT 2005

**Become a Comprehensive
Energy Company
for Sustainable Growth**



NIPPON OIL CORPORATION
Your Choice of Energy

Corporate and Group Overview

Company name: Nippon Oil Corporation (NOC)
 Founded: May 10, 1888
 Representative Director, Chairman of the Board: Fumiaki Watari
 Representative Director, President: Shinji Nishio
 Capital: 139.4 billion yen
 Listed stock exchanges: Tokyo, Osaka, Nagoya,
 Fukuoka, Sapporo
 Consolidated net sales: 4,924.2 billion yen (FY2005)
 Number of consolidated employees: 13,424 (As of March 31, 2005)
 Website: <http://www.eneos.co.jp/english/>

Nippon Oil Corporation holds the right in Japan to the ENEOS trademark and logo. The Company and its subsidiaries offer their products and services under the ENEOS brand.

Overview of the NOC Group Companies

- Oil Refining & Wholesaling Nippon Petroleum Refining Co., Ltd.
Nihonkai Oil Co., Ltd.
- Petrochemical Business Nippon Petrochemical Co., Ltd.^{*1}
- Exploration & Production Business Nippon Oil Exploration Limited
- Gas Business Nippon Petroleum Gas Co., Ltd.^{*2}
- Oil Storage Nippon Oil Staging Terminal Co., Ltd.
Shibushi Oil Storage Co., Ltd.
Kamigoto Oil Storage Co., Ltd.
Okinawa CTS Corporation
- Lubricants Nippon Petroleum Processing Co., Ltd.^{*3}
Wakayama Petroleum Refining Co., Ltd.
- Oil Transport Nippon Oil Tanker Corporation
- Construction & Engineering NIPPO Corporation Co., Ltd.
- Others Nippon Oil Real Estate Co., Ltd.
Nippon Oil Trading Corporation
Nippon Oil Business Services Co., Ltd.
Nippon Oil Research Institute Co., Ltd.
Nippon Oil Information Technology Corporation

*1. On April 1, 2006, Nippon Petrochemical's headquarters departments (administrative, marketing, and R&D departments) are to be split off and merged into the parent company.
 *2. Nippon Petroleum Gas was absorbed by the parent company on July 1, 2005.
 *3. Nippon Petroleum Processing is scheduled to be absorbed by Nippon Petroleum Refining in FY 2007.

Scope of Report

- Reporting period: This report focuses on FY2005, ended March 31, 2005, but it may also include more recent information.
- Organizational units: The data and reports cover the 19 main companies* of the NOC Group. When the scope of organizational units covered by data or reports is different, this scope will be specified.
 NOC: refers to Nippon Oil Corporation alone
 NPRC: refers to Nippon Petroleum Refining alone
 NOC Group: refers to the above-mentioned 19 companies
- Data on SO_x, NO_x, and other environment-related information for each refinery, plant, and other facility is scheduled to be posted on the Company's website from October 2005.
- Date of publication: August 2005

* The number of main companies of the NOC Group listed above has been increased by two since the previous fiscal year. Three companies were added—Nippon Oil Business Services, Shibushi Oil Storage and Kamigoto Oil Storage—while Nippon Auto Parking Co., Ltd. was absorbed by Nippon Oil Real Estate.

Financial Highlights

For detailed information on performance and financial data, please refer to such materials as the Company's *Securities Report (Yuka Shoken Hokoku-Sho)*, IR Station (*Business Report*), and *Fact Book*. These materials may be found on the Company's website.

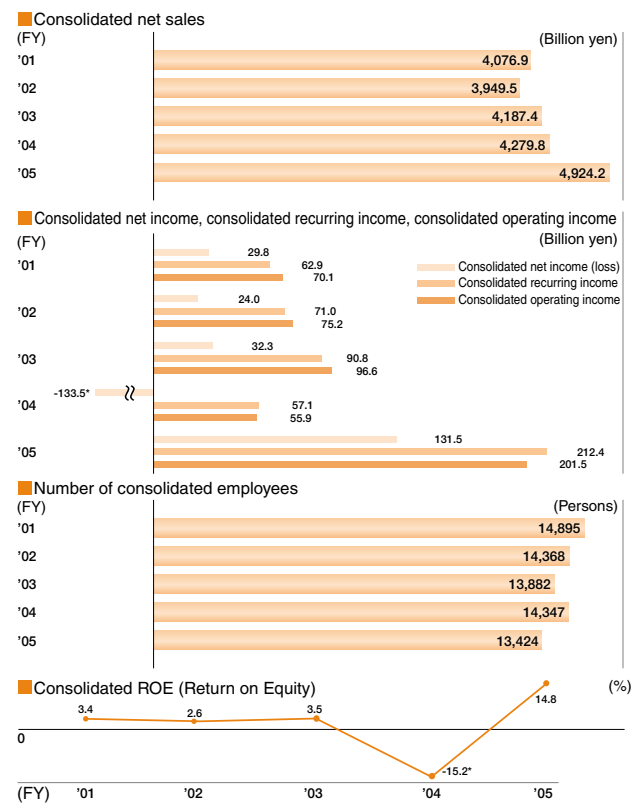

* This resulted from such factors as NOC's early application of accounting standards related to the impairment of fixed assets, which led to 171.5 billion yen in special losses.

Editorial Objectives

This report has been prepared with the objective of providing conscientious and easy-to-understand disclosure of information related to the corporate social responsibility (CSR) activities of the Nippon Oil Corporation Group (NOC Group). This report has the following important features:

- Beginning with the issuance of the Group's *Environmental Report* in 2000, the Group has published reports focusing on its environment-related activities. In 2003, the Group issued its *Sustainability Report 2003*, which included reports on social matters. Recently, along with the positioning of CSR activities as a basis for corporate management, the name of this report has been changed to the *CSR Report (Corporate Social Responsibility Report)*.
- This report includes information on six CSR focus areas: Compliance, Information Security, Quality Assurance, Environment & Safety, Social Contribution, and Respect for Human Rights and Dignity.



ENEOS Brand Symbols
 The ENEOS logo mark graphically represents the concept of energy. The central sphere represents the NOC Group's reliability and permanence, and the lines spiraling outward represent the creativity and innovation of the Group's operations.

(ENEOS was coined from the words "energy" and "neos," which means "new" in Greek.)

C O N T E N T S

01 Corporate and Group Overview, Editorial Objectives

03 Top Commitment

05 Group Philosophy

06 Medium-Term Consolidated Management Plans

● Enforcement of Corporate Governance

07 Corporate Governance

08 Reinforcement of CSR-oriented Management

● To Be a Fair and Honest Company

09 Compliance

● Aiming for Appropriate Management and Disclosure of Information

11 Information Security

● Ensuring the Satisfaction of Each and Every Customer

13 Assuring the Quality of Products and Services

15 CSR Initiatives at Service Stations

● Aiming for Environmental Harmony

17 Environmental Activities

29 Ensuring Safety

● Contributing to Society as a Corporate Citizen

31 Social Contributions

● Aiming for Vitality and Self-Fulfillment in the Workplace

34 Respect for Human Rights and Dignity

37 Stakeholder Comments

39 Relationships with Stakeholders

40 Independent Report

We continue to supply environmentally-friendly energy toward the creation of a sustainable society

What does corporate social responsibility (CSR) mean to the NOC Group?

In recent years, the circumstances for corporations have undergone major changes. For a company to develop in a sustainable manner, it is necessary for the society or the vessel that contains the company to accomplish sustainable development itself. Companies must do more than just pursuing profits; they must also contribute to society actively as corporate citizens.

We have conducted our business activities for more than 100 years since the Company foundation to maintain the stable supply of energy, which is indispensable for people's lives and economic activities.

"To be at balance with nature and to contribute to society as we provide each customer with complete satisfaction through our global and comprehensive energy operations." We trust this very philosophy aptly represents what our social responsibilities are.

We hold as our basic CSR policy that everyone in the Group steadily fulfills his or her responsibilities to society by diligently putting the business philosophy into practice as well as works to establish a corporate group that is worthy of the confidence of all its stakeholders. We will continue to pursue CSR along these lines.

How do you promote your CSR-oriented management?

For enhanced CSR-oriented management, we reorganized our Internal Audit Department into the Corporate Social Responsibility (CSR) Department in July 2004. Four CSR focus areas were defined: Compliance, Environment & Safety, Quality Assurance, and Respect for Human Rights and Dignity. In June 2005, we added two more areas, Information Security and Social Contribution, establishing the NOC Group CSR Committee to oversee all these organizations.

What must be kept in mind is that the task of putting the CSR into practice rests with each and every employee. We believe the awareness is important that CSR is no monopoly of the CSR Committee or departments in charge but is also the responsibility of each individual working in the organization. We see to it that this will be well observed and put into effect.

How is "Environmental Harmony" reflected in your business activities as you hold it in your Group Philosophy?

"Harmony between the environment and economy" is often heard. Our thinking, however, is that the "environment" comes first and economic development is possible only within the framework of the environment.

The energy industry has become substantially less compartmentalized, with oil, electric power, and gas; rendered more interchangeable than in the past along with the deregulation of the power industry. All companies in the energy industries have begun to compete with one another to provide greater energy efficiency and to reduce the environmental impact. We at the NOC Group are looking well into the future, and our initiatives include the supply of sulfur-free (10ppm or less sulfur content) gasoline and diesel fuel, kerosene cogeneration systems, and commercializing the world's first fuel cell systems using LPG for household use.

We have a goal of posting 190 billion yen in consolidated recurring income in the concluding year of our Third Medium-Term Consolidated Management Plan (FY 2006 to FY 2008). We believe that the generation of such income is possible only when all our activities will have been compatible with the environment. In other words, we consider it ideal to have the equation that our profit is the total sum of our business activities that are friendly and compatible with the environment. We wish to be in a position to report profit while maintaining our fast commitment to the environment.

The NOC Group is promoting CSR-oriented management. What are your visions 20-30 years from now about what your corporation will be doing in terms of social responsibilities?

Even in 2030, petroleum is projected to share the largest source of primary energy consumption. It is regarded to be the potential source for hydrogen production, comes hydrogen society. As we constantly call for a shift from "quantity to quality", the assumption of the energy industry from now on cannot be consumption in large volumes but

should rather be coexistence with the environment. We believe that energy companies must contribute to the realization of a qualitatively affluent life in its truest sense by actively offering products and systems that enable us to use energy efficiently.

It is equally important that consumers also share a strong sense of awareness concerning energy conservation and that corporations and consumers together collaborate to promote the efficient use of energy as well as nurture a culture that advocates and practices conservation.

The ultimate goal of our CSR-oriented management is the creation of a sustainable society, as our Company aims to be a comprehensive energy company with the strongest popular support. By continuing to supply environmentally-friendly energy as well as maintaining new energy technology development, we wish to contribute to the benefits of society actively way into the future.

Dear Readers

We hope the foregoing explains the concepts and initiatives of the NOC Group's CSR-oriented management. We would like to continue our efforts to enhance the quality of these activities through two-way communications with our stakeholders, and would greatly appreciate hearing your most candid, forthright views and opinions.



Representative Director,
Chairman of the Board,
Nippon Oil Corporation

F. Watari
Fumiaki Watari

Representative Director,
President,
Nippon Oil Corporation

S. Nishio
Shinji Nishio

Group Philosophy

Nippon Oil Corporation Group Philosophy

[Group Slogan] **Your Choice of Energy**

This slogan reflects the NOC Group's ambition to be people's first choice for all their comprehensive energy needs.

[Vision] To constantly find new ideas to face the challenges of the future as we strive to become people's first choice in comprehensive energy solutions.

[Mission] To be at balance with nature and to contribute to society as we provide each customer with complete satisfaction through our global petroleum and comprehensive energy operations.

[Standards of conducts/Six values we respect]

Our operations are focused on "ENERGY."

Ethics

We apply a high ethical standard to all of our corporate activities and respect fairness and honesty in all that we do.

New ideas

We constantly create business through new ideas covering petroleum and a wide range of other energy options.

Environmental harmony

We recognize the influence that corporate activities have on human beings and their environment. As a global citizen, we strive to be at harmony with the environment.

Relationships

We value relationships with our customers, business partners, shareholders, employees, and local communities. Our goal is to contribute to their comfort and well-being.

Global approaches

We carry out our corporate operations in Japan, the rest of Asia, and around the world in a manner that meets global standards.

You

We believe that providing you with complete satisfaction is the basis of all of our corporate activities, and because of this, we strive to deliver high quality products and superior services.

Medium-Term Consolidated Management Plans

The NOC Group is aiming to establish systems for integrated operations and to become a comprehensive energy company by FY 2011. To attain these goals, the Group issues consolidated management plans every three years.

Attainment of Second Medium-Term Consolidated Management Plan Targets

In line with its Second Medium-Term Consolidated Management Plan, which covered the period from FY 2003 to FY 2005, NOC worked to increase its consolidated ROE and strengthen its financial position. As a result, it was able to boost its ROE to 14.8% (10.7% excluding inventory valuation factors), considerably above the target of 6.5%. The Group aimed to reduce the level of interest-bearing debt to 900 billion yen by March 31, 2005, and it was able to lower the level to 965.2 billion yen. This reflected the expansion of strategic investments in oil and natural gas development operations aimed at strengthening the Group's profit base.

Overview of the Third Medium-Term Consolidated Management Plan

The Group's operating environment is being affected by such trends as sluggish growth in domestic demand for petroleum products and the expansion of harsh competition both within and between different segments of Japan's energy industry. The Group is also facing changes related to growing needs to undertake environmental countermeasures associated with global warming and other issues as well as to respond to major market structure changes stemming from the growth of Asian energy markets.

In view of these situations, the Group, in April 2005, began implementing its Third Medium-Term Consolidated Management Plan, which is designed to strengthen the foundation for a future surge of corporate development. This plan gives strong emphasis to the following two objectives.

Positioning of the Third Medium-Term Consolidated Management Plan

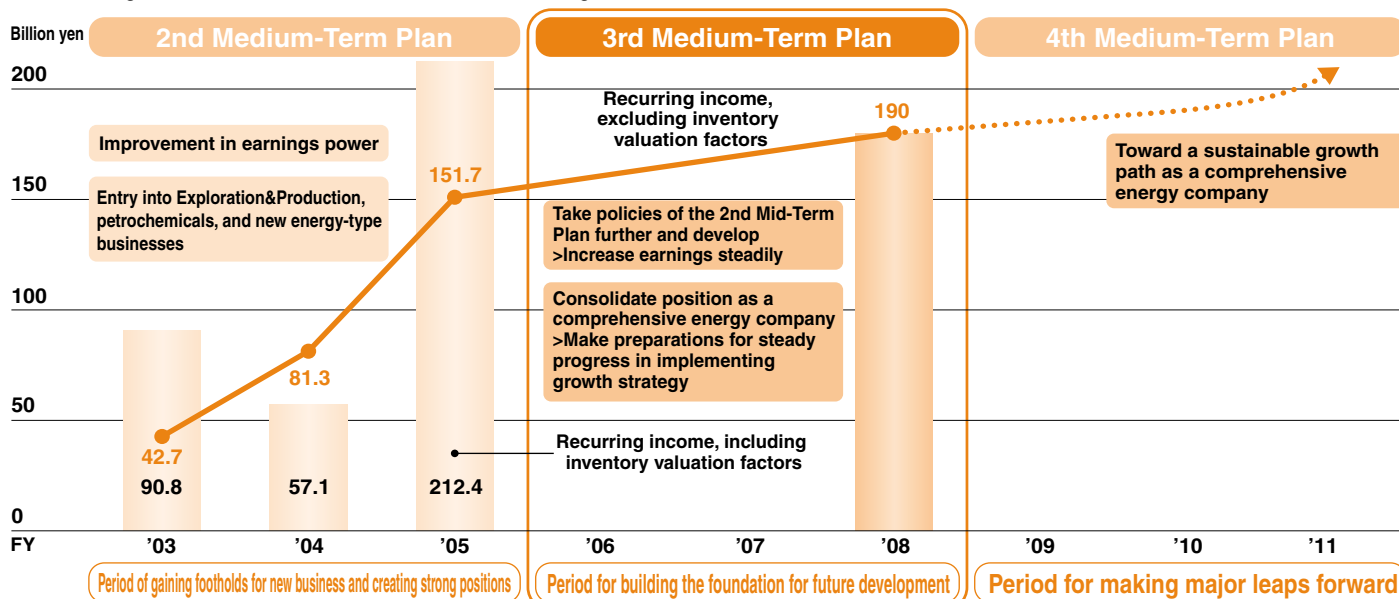

- ### Principal Issues of the 3rd Medium-Term Plan
1. Generating cash flow from core businesses (Oil exploration & production, refining/marketing, petrochemical business)
 2. Building business models needed to realize fundamental strategic goals

- ### Performance Indicator Goals
1. Financial goals (in FY 2008)
 - Consolidated recurring income: 190 billion yen (excluding inventory valuation factors)
 - Consolidated ROE: 10%
 2. Cost reductions and efficiency increases
 - We will undertake distribution rationalization measures, the reduction of maintenance and amortization expenses, and other measures aimed at reducing costs by 33.0 billion yen over three years.
 3. Capital investments
 - We will implement 500.0 billion yen in capital investments concentrated in strategic growth fields.
 4. Cash flows
 - (1) Increase in return to shareholders
 - We will increase cash dividends per share to 12 yen.
 - (2) Reduction of interest-bearing debt
 - We will work to reduce interest-bearing debt to 900.0 billion yen or less. However, if promising investment opportunities emerge, we will respond flexibly and give greater priority to the investments than the debt reduction goal.

Note: Please see the Company website for more information on the Third Medium-Term Consolidated Management Plan.

Enforcement of Corporate Governance

Corporate Governance

The NOC Group is working to augment and strengthen its capabilities for implementing corporate strategies and its corporate governance systems, with the goals of establishing systems for rapid and dynamic decision making and operational execution as well as ensuring the transparency and soundness of management.

Basic Aims of the Reforms of Governance Systems

Amid a further increase in the harshness of the competitive environment for energy companies, the Group has a strong need to upgrade its management strategy development capabilities and establish a system for "rapid and dynamic decision making and operational execution" that is responsive to changes in the business environment.

In response to changes in the shareholding structure, the Group is further increasing its emphasis on shareholder value. At the same time, as increasing attention is focused on the concept of corporate social responsibility (CSR), the Group believes it must further augment its efforts to ensure the "transparency and soundness of management" in order to gain the trust of all its stakeholders.

To respond to such changes in the business environment, the Company took the following corporate governance reform measures during FY 2005.

1. Direction of Corporate Governance Reforms

In view of its history, business modes, and future business strategies, the Company has chosen to implement reforms that promote the strengthening of its Board of Auditor system.

2. Concrete Contents of Corporate Governance Reforms

(1) To strengthen Group management, the presidents of the three main NOC subsidiaries (Nippon Petroleum Refining, Nippon Petrochemical, Nippon Oil Exploration) are added to members of NOC's Board of Directors. In addition, the three companies' important capital investments and other items necessary for the Group's strategic management are discussed for approval or reported at NOC's Board of Directors' meetings.

(2) The number of directors specified in the Company's Articles of Incorporation has been reduced from "30 or less" to "20 or less."

(3) The term of directors has been reduced from two years to one year.

(4) Executive officers have been elected from among all division executive directors, deputy division directors, and general man-

agers of departments/laboratories/offices/branches on the basis of the criteria that they meet the required qualifications as leaders among employees and have the necessary capabilities for managing a major division, with the aim of establishing a rapid and responsive system for the conduct of business operations.

(5) To strengthen the auditing system, without waiting for the end of the grace period offered by Japan's Commercial Code, the Company has moved to ensure that three of its five Board of Corporate Auditor members are full-fledged "outside auditors" unaffiliated with the Company, thereby creating a system able to supervise and control management from an objective and fair perspective. In addition, as another means of strengthening the auditing system, a secretariat for Board of Corporate Auditor members has been created, thus clearly making the secretariat for the financial auditor's audits and the Board of Corporate Auditors' audits independent from operational execution units.

Progress in Introduction of Executive Officer System

In NOC, the chairman of the board has chaired the Board of Directors, and the president is responsible for operational execution. To serve as a consultative body for the president, the Company has established the Executive Committee comprised of the president, executive vice presidents, and Senior Vice Presidents. The Executive Committee assists the president with respect to operational execution.

The Board of Directors supervises and controls the operational execution of the president as well as makes important management decisions based on laws, regulations, and NOC's Articles of Incorporation. In addition, the Board of Corporate Auditors and its members audit the Board of Directors and representative directors, and the financial auditing company performs financial audits. In these ways, we are working to strengthen NOC's business supervision and control capabilities.

Organization of Operational Execution and Management Supervision

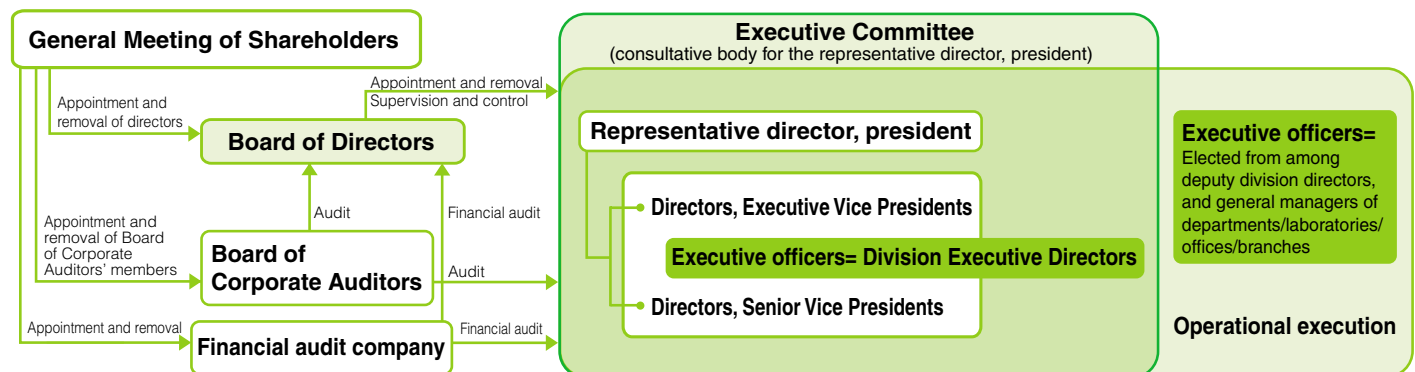

Reinforcement of CSR-oriented Management

To respond to the expectations of stakeholders and inspire still-greater trust on the part of society, the NOC Group is strategically promoting the reinforcement of its CSR.

Establishment of the CSR Department

In July 2004, the NOC Group defined four focus areas in its efforts to promote CSR-oriented management, namely "Compliance," "Environment & Safety," "Quality Assurance," and "Respect for Human Rights and Dignity," and stepped up the initiatives in these specified areas. At the same time, the CSR Department was reinstated immediately under the president as it inherited the internal auditing functions from the defunct Audit Department, and assumed the role of planning and making recommendations for the CSR-oriented management. These moves have resulted in the creation of a CSR-oriented management promotion system.

Establishment of Group CSR Committee

In June 2005, "Information Security" and "Social Contribution" were added to the previous four areas of CSR activities, now comprising six defined areas. To integrate the CSR operations in these six areas and provide unified oversight for the entire Group, we established the CSR Committee (chaired by the president) and six subordinate organizations (chaired by the associated executive directors

of divisions (Please refer to the accompanying chart). Through these activities, we aim at the establishment of an industry group that steadily fulfills its responsibilities to society with the support of its individual employees' devotions to live up to the Group Philosophy.

Group CSR Questionnaire

In May and June 2005, NOC distributed a CSR questionnaire to officers and employees (approximately 11,000 persons) of our 19 Group companies. The survey was aimed at helping to gain a better understanding of the level of their awareness regarding the ethical and compliance issues and at the same time identify what potential risks are conceivable. For utmost candidness the questionnaires were filled out anonymously and were picked up and analyzed by neutral third parties. The response rate to the questionnaire was 80%, enabling us to confirm the high interest in participation in CSR and compliance activities among employees, but we also learned that there were some issues related to the permeation of the Group Philosophy into the corporate culture and communication in the workplace. We, therefore, decided to hold meetings at the workplace level with the participation of all employees using the analysis of the questionnaire results as subject for discussion. The NOC Group is committed to continuing effective CSR activities that take account of the views and suggestions of employees.

The NOC Group's CSR Promotion System

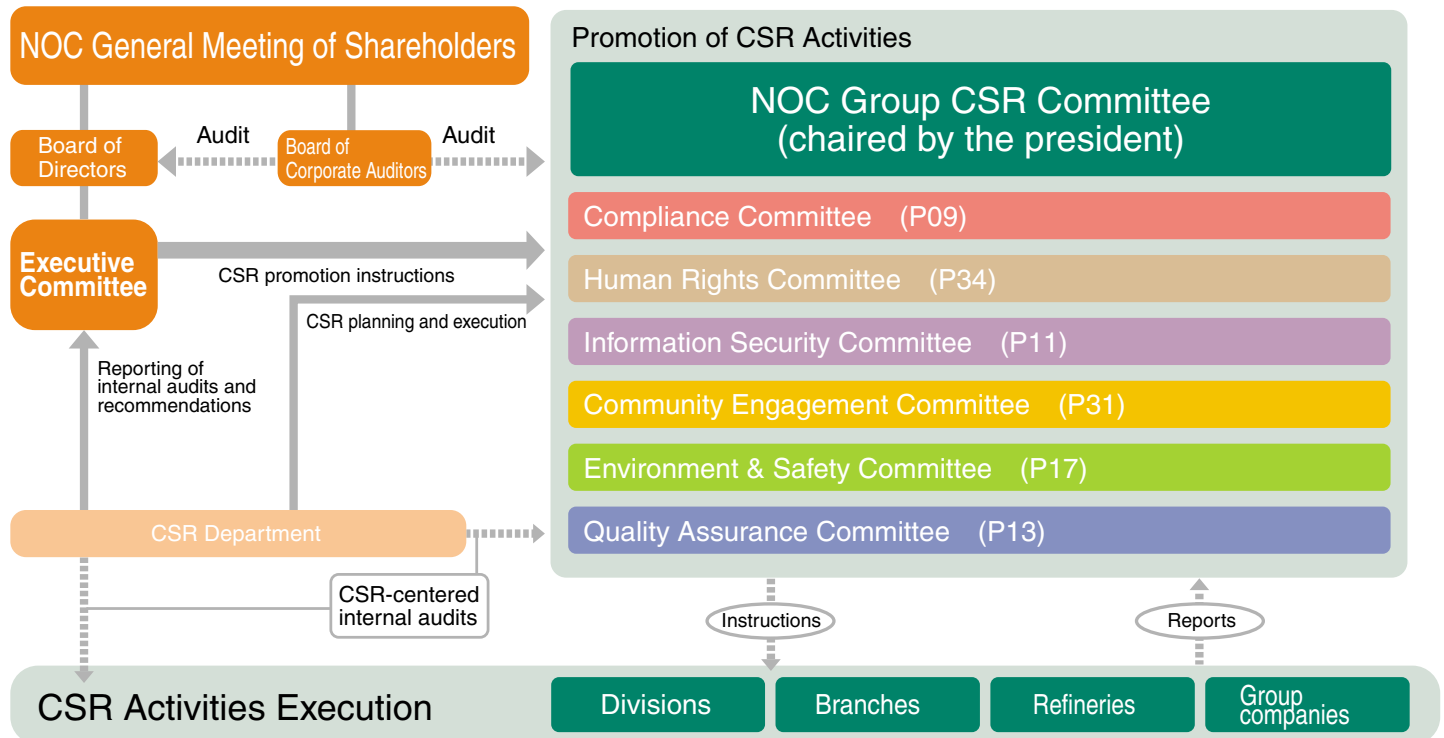

Compliance

Based on its belief that companies are public institutions, the NOC Group strives to act as an excellent corporate citizen in all of its operations while maintaining high ethical standards and constantly emphasizing fairness and honesty.

Compliance-Related Activities

Against the backdrop of numerous recent corporate scandals, and the trend of globalization, companies are being required to shift from a single-minded focus on economic performance to a more comprehensive perspective on fulfilling their responsibility to society and ensuring that all their activities are fair and open.

The first item of the NOC Group philosophy, "Standards of Conducts/Six Values We Respect," is "Ethics (Fairness and Honesty)." Besides offering concrete action guidelines to promote rigorous legal compliance and high ethical standards on the parts of all Group officers and employees, this item strongly calls for such compliance and ethical standards to be consistently implemented in all aspects of Group operations. Recognizing that compliance is a principal element of corporate ethics and that rigorous compliance is extremely important, each Group company has established their own compliance rules.

In June 2005, accompanying reforms in the CSR promotion system, the Group established the NOC Group Compliance Committee under the CSR Committee. Each Group company has stepped up their concerted efforts to ensure rigorous compliance while implementing standardized measures.

Legal Surveys and Compliance Performance Checks

Each Group company annually performs checks of its compliance performance to confirm that the company's operations and the behavior of the company's officers and employees do not conflict with relevant laws and regulations. If a problem or questionable case is discovered, measures to rectify the situation are immediately taken. Before the checks, surveys of laws and regulations related to the company's operations are performed, and other measures are taken to accumulate legal expertise enabling the prevention of legal compliance problems before they occur as well as the promotion of up-to-date, compliance-related knowledgeability among all the company's officers and employees.

Internal Reporting System

If employees discover cases of illegal behavior associated with business operations or receive reports of such behavior, they are to quickly report the situation to their superiors, consult with their superiors, and proactively work to rectify the problematic situation. An internal reporting system for reporting discoveries of illegal behavior has been established, and this system is designed to ensure that employees reporting illegal behavior will not suffer any work-related disadvantages due to their having made reports.

Education and Training

To promote recognition that corporate ethics and compliance depend on the responsible manner in which each employee performs his/her daily work, each NOC Group employee undergoes education and training related to compliance as well as relevant laws and regulations.

(1) Training

Various training courses are organized whenever necessary, including legal knowledge training for staff of each of the parent company's divisions and facilities, and training courses for employees with compliance responsibilities.

(2) Legal Compliance and Operational Regulation Compliance Database

NOC has created a database of concrete measures and matters to keep in mind with regard to the laws and regulations associated with each NOC unit's operational field and regarding the maintenance of good compliance with those laws and regulations. This database is made available on the Group intranet, to enable information sharing throughout the Group. In addition to indexing the material by individual operational fields, the contents of individual laws are also indexed.

(3) "Fount of Compliance" Legal Affairs News Bulletin

Each week, NOC posts a compact and easy-to-understand issue of the "Fount of Compliance" legal affairs news bulletin, which amounts to approximately one A4-size page of data on such issues as basic legal knowledge; current events; what is considered "common sense" in society; and in-house rules. This bulletin is posted on the Group intranet so that all Group officers and employees can read it.

(4) Compliance Library

Also posted on the Group intranet is NOC's Compliance Library, a compilation of text containing the basic legal knowledge needed by people and companies. This library can be used freely by those in the Group—for example, employees can use it to confirm their knowledge of relevant laws and regulations, and each Group unit can use it as a part of their officers' and employees' training programs.

Suspicion of Antimonopoly Act Violations in Connection with the Supply of Petroleum Products

NOC and ten other companies were charged with the possible violation of the Antimonopoly Act in connection with designated bidding for the right to supply petroleum products to the Japan Defense Agency, and were found guilty by the Tokyo High Court on March 24, 2004. Concluding that this judgment was based on a major misrepresentation of the facts, NOC appealed the case to Japan's Supreme Court on April 5, 2004.

In connection with the same round of bidding, Fair Trade Commission of Japan ruled that NOC and ten other companies should be excluded from certain transactions based on the Antimonopoly Act. NOC and two other companies are appealing this ruling, and it is currently being considered by the Commission.

Crisis & Emergency Countermeasures

The fundamental principle of effective crisis management is to make unrelenting daily efforts to prevent troubles and accidents from happening. Based on its rigorous compliance programs, the NOC Group does make such efforts with a comprehensive range of materials, including operational manuals as well as through well-coordinated educational and consciousness-raising activities.

Business activities entail diverse risks. They may be natural disasters, major accidents, economic conditions, social and political upheavals as well as risks that directly affect the corporate management. At the NOC Group, we fully realize that these risks are real and have drafted Crisis & Emergency Response Rules for dealing effectively with major disasters, accidents that may jeopardize the management as well as any irregularities that may seriously damage the Group's image and reputation. The crisis Management Group was created in General Administration Department in July 2005 with the aim of strengthening our crisis management system.

In the event of a crisis or emergency, we will respond, with top priority given to human life as well as the natural environment, to cope with the situation with our optimal measures and resources, while endeavoring to ensure centralized information gathering as well as accurate and rapid disclosure. The Group will promote Business Continuity Management for dealing with large-scale disasters and various other situations.

Examples of Potential Risks

Disaster/	Natural disasters	Earthquakes, typhoons, inclement weathers
Accident risks	Major accidents	Fires at the Headquarters Building and/or refineries, equipment troubles
Political and socioeconomic risks	Political Economic	Wars, revolutions, systemic changes Economic crises, foreign exchanges, interest rates
Management risks	Technical/ product Management Information	Product liability, intellectual property violations Antitrust violations, boycotts Confidential information leaks, insider-trading
	Information system	Unauthorized access, virus infection
	Environmental	Pollution of groundwater, air, soil
	Financial	Losses on futures transactions, bankruptcies
	Personnel/ Labor	Wrong-doings by officers and/or employees, industrial accidents
	Competitive	Insufficient risk-response capabilities, insufficient profit-earning capabilities

Responses to Accidents and Troubles

Unfortunately, we had several accidents in FY 2005, as described below. We deeply regret this and are striving to ascertain the causes of the accidents and take effective steps to prevent any recurrences in the future.

Date	Nature of Accident	Prevention Measure
July 2004	Some regular gasoline was accidentally mixed into premium gasoline during the unloading from a tank truck at a service station in Kanagawa Prefecture, and the adulterated premium gasoline was inadvertently sold due to a lack of proper communication. We immediately followed up with our public apologies and explanation of the remedial measures taken via newspaper advertisements, signs at the service station, and other available routes.	We have confirmed the rigorous conformity to the specified unloading procedures with the transport companies, and beefed up the safety meetings with our safety managers and executives of the transport company. The truck company in question now has improved communication systems internally.
September 2004	An employee of our partner company inhaled hydrogen sulfide gas during the regular checkup and repair of a heavy oil desulfurization unit at the Mizushima Refinery of NPRC. He was temporarily hospitalized, and required 39 days of recuperation before returning to work.	Further to ensuring the wearing of the protective gear against possible exposure to harmful gases, a survey was conducted to confirm compliance among all employees with the prescribed rules in the wake of the incident. Moreover, improvement was made on protective gear to facilitate the rapid and correct donning.
October 2004	A vacuum distillation unit at Sendai Refinery of NPRC had a corroded pipe section, which broke and caught fire. The refinery's own fire-fighting unit took to the scene to fight it and with the aid of municipal as well as district fire-fighting units put it out in about 40 minutes.	We have seen to it that inspections are conducted at relevant facilities of the entire Group for similar defects to prevent future recurrences; inspection processes were reevaluated, and several measures were taken to ensure a higher level of safety consciousness. In addition, programs were undertaken to increase facility reliability, prevent the occurrence of similar incidents, strengthen and augment equipment management technologies, and promote the sharing of information.

Information Security

Recognizing that ensuring information security is a crucial corporate mission, the NOC Group takes thorough measures to ensure the appropriate handling of personal information and all other types of corporate information.

Information Security Measures

The NOC Group has moved forward with information security measures in the past, but Japan's full-scale implementation of the Personal Data Protection Law has further increased the rigor with which personal information must be handled. Accordingly, we have taken various measures to create systems that increase the thoroughness of our information security capabilities.

Specifically, in April 2005, we appointed a chief privacy officer (CPO) in NOC to assume responsibility for personal information management and also appointed information administrators to take responsibility for such management in each NOC Group department. In addition to these measures to upgrade and improve overall management systems for corporate information, we created two sets of regulations prescribing concrete methods for handling confidential information and personal information—"Confidential Information Handling Rules" and "Personal Information Protection Rules". Moreover, we drafted a Groupwide personal information protection policy, the "NOC Group Privacy Policy," and made an announcement of this policy.

Each Group company obtains a written pledge to rigorously manage information from each of its employees and members of management and also provides educational courses on e-learning that help ensure that all officers and employees are well acquainted with the nature of information-related rules and regulations.

The June 2005 expansion of NOC's CSR promotion system resulted in the creation of the NOC Group Information Security Committee under the CSR Committee. In the Information Security Committee, the Group is concertedly working to strengthen its system for promoting additional information security measures.

The screen of e-learning



ENEOS Personal Information Protection Guidebook

The ENEOS Personal Information Protection Guidebook has been distributed to all ENEOS brand service stations, and thorough measures are being taken to ensure the safe and appropriate handling of personal information at service stations.



Basic Policy for Corporate Information Security

- 1. Recognizing the importance of corporate information as an asset**
Positioning corporate information as an important corporate asset, the Group will prevent information leaks and unauthorized access to information and maintain corporate information in a condition that enables its appropriate use.
- 2. Respecting the rights of individuals**
Respecting the privacy of individuals, the Group will not allow access to information related to officers, employees, and customers without the authorization of the employees responsible for handling the relevant operations.
- 3. Complying with laws and regulations**
When using or displaying corporate information, the Group will comply with relevant laws and regulations as well as its own internal rules.
- 4. Emphasizing the interests of stakeholders**
The Group will beneficially and appropriately manage corporate information while emphasizing the interests of shareholders, investors, financial institutions, consumers, suppliers, and other stakeholders.
- 5. Implementing appropriate public relation activities**
The Group will undertake proper in-house and external information dissemination activities designed to prevent the risk of such problems as those involving mistaken reports and unfounded rumors.

Overview of the NOC Group Privacy Policy

Establishment of Personal Information Protection System

- Appointing a chief privacy officer (CPO) to protect personal information in NOC and appointing information administrators to take responsibility for information management in each NOC Group department
- Ensuring thorough protection of personal information by taking related measures in compliance programs and continuing to implement and improve these measures

Personal Information Safety Management

- Taking thorough personal information safety management measures to prevent information leaks and unauthorized access to information

Clarification of Information Usage Objectives

- Clarifying personal information usage objectives and usage authorization criteria
- Prohibiting usage other than the way in accord with personal information usage objectives

Provision of Information to Third Parties and Consignment of Information Management

- Prohibiting, in principle, the display or provision of personal information to third parties
- Ensuring, when personal information is displayed or provided to third parties, that the third parties are obligated to appropriately manage personal information

Response to Customer Inquiries Regarding Their Own Information and to Such Customer Requests as Those Regarding the Display, Correction, or Usage Discontinuation of Their Own Personal Information

- Thoroughly confirming the identity of customers and quickly making appropriate responses to requests

Communications

● Shareholders' Meetings and Investor Relations (IR) Explanation Meetings

NOC introduced proxy voting via the Internet in 2005 to make it easier for shareholders to participate in shareholders' meetings and is taking steps to put all proxy voting methods in order. In addition, for the convenience of foreign shareholders, NOC posted an English-language version of the notice for the convening of the annual general shareholders' meeting on its website.

Aiming to promote better understanding of its management policies and business operations among securities analysts and fund managers, NOC holds quarterly performance explanation meetings and proactively organizes various types of such events as business explanation meetings and facility tours. We also offer our financial reports and a full array of other IR materials via our website, which is visited by a large number of investors.



Presentation on financial results

● Exhibitions

To deepen the understanding of its business operations, NOC proactively participates in various exhibitions, such as the 2004 New Environmental Exhibition, the JIMTOF2004 Japan International Machine Tool Fair, and the Energy and Environment Exhibition 2005. At the Eco-Products Exhibition 2004 held in December 2004, for example, NOC explained its efforts to help protect the environment through the use of panels and displayed its fuel cell systems and other products, thereby communicating with the more than 7,000 people who visited that exhibition.



NOC's booth at the Eco-Products 2004 Exhibition

● Symposia

More than 1,000 people attended the "Symposium for Energy in the 21st Century—East Asian Energy Supply and Demand, and Japan's Choices" event, which was organized by NOC in cooperation with NHK Enterprise 21. Focusing on what Japan's public- and private-sector entities should be doing in light of rising global demand for energy, the event included keynote speeches and a panel discussion.



Panel discussion

● Communication with Local Communities

As part of activities to build good relationships with local communities, the NOC Group is working to improve communication. These initiatives include sponsoring tours of our facilities and working together with Junior Eco Club* to promote environmental education activities. The NOC Group also participates in local events and issues newsletters to the local communities. In addition, the Group also posts information on local interchange activities and events on its website.



Tour of the Negishi Refinery

*Sponsored by the Ministry of the Environment, Junior Eco Club programs include various environmental education activities for children attending primary and junior high schools.

● Customer Consultation Service

The NOC Group has provided a customer consultation service. Persons with inquiries, opinions, complaints, and other matters may communicate with NOC by calling a toll-free number, via the NOC website, and by other means. The valuable information gathered from customers is made available to all members of management and employees, and the content is reflected in the NOC Group management. Also, information related to service stations is analyzed and then used to make improvements. In FY 2005, approximately 37,000 inquiries and about 1,000 complaints were received. As a result of efforts to provide quick service and avoid keeping customers waiting, we were able to reduce the waiting time about 15% in comparison with FY 2004. In addition, beginning in FY 2006, the NOC Group is making use of the *Service Station Complaints Handling Guidebook*, to deal more effectively with issues raised by customers.

■ Customer Consultation Service Workflow

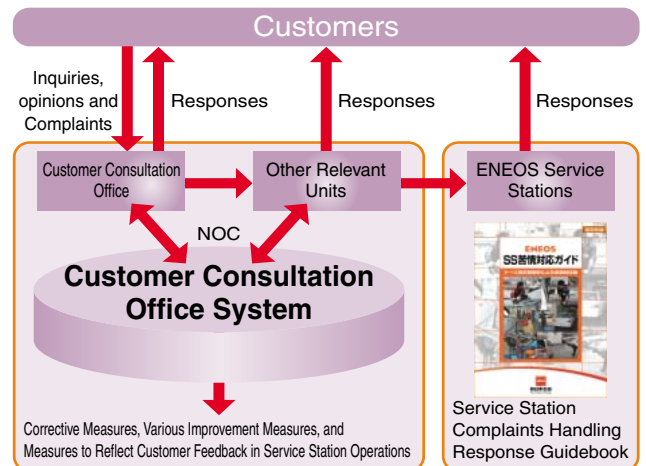

Assuring the Quality of Products and Services

The NOC Group is working to improve the quality of its core ENEOS brand products as well as the quality of its services.

Quality Assurance System

To provide high-quality products that will win customer satisfaction, the NOC Group has decided to make “Quality Assurance Rules”, a basic item in its product quality program. The Group has made “quality assurance” a CSR focus area, and, accompanying the reforms in the CSR promotion system in June 2005, formed the NOC Group Quality Assurance Committee under the CSR Committee. This new committee is now engaged in activities to further assure and improve the quality of products and services.

Organization of the NOC Group Quality Assurance

NOC Group Quality Assurance Committee

Consider the NOC Group quality assurance and quality control policies

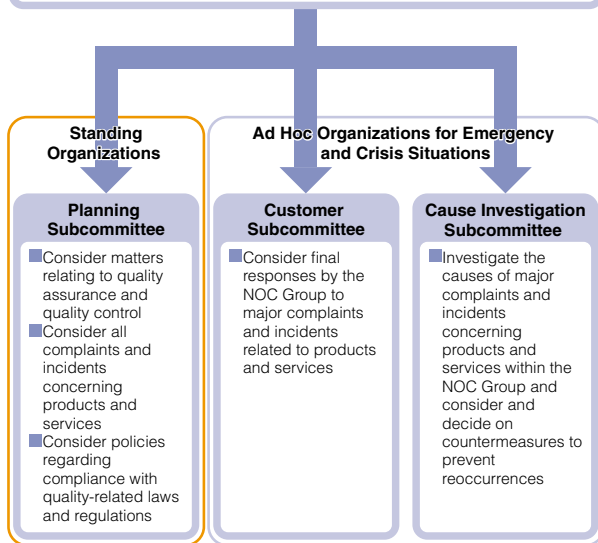

Examples of the NOC Group Quality Assurance Activities

Refineries

1.Zero Complaint Activities*1

- Strengthening shipment control systems
- Strengthening process-specific quality management
- Ensuring precise performance based on rules

2.Zero Trouble Activities

- Reviewing and improving the complaint prevention measures in the course of work process

Tankers

- Conducting quality training and ensuring adherences to pre-loading criteria*2
- Reviewing work processes and equipment where trouble may occur
- Confirming orders

Trucks

- Encouraging “Thanks!” campaigns*3
- Eliminating complaints regarding driving problems
- Continuing safety countermeasures

*1 Initiatives to eliminate quality-related complaints in refineries and elsewhere by making information related to quality issues available across the refineries.

*2 Criteria in loading that take account of possible influence on quality of cargoes by previous ones carried on the tankers or trucks.

*3 Initiatives to prevent improper transport and unloading by encouraging truck drivers to speak first with service station staff and unload products under their supervision.

Quality Assurance Activities in FY2005

1.Creating and Reinforcing Quality Assurance System

Each Group company has established quality assurance committees and organizations for implementing the committees’ policies, and they have also clarified their rules for responding to complaints.

2.Process Management and Product Quality Assurance

The Group has clearly identified new quality assurance related tasks and taken measures to complete the tasks and prevent quality problems. Tasks were identified with respect to all processes from ordering through manufacturing, storage, and distribution processes. In particular, each unit and facility was encouraged to increase the dynamism of its efforts to solve quality assurance problems by arranging for the organization of such efforts within the framework of campaigns centered on Autonomous Quality Pledges— pledges by each unit and facility to autonomously achieve quality assurance goals.

3.Improving the Quality of Services

To improve the quality of the services it provides, the NOC Group is drafting and implementing plans for various activities based on a systematic Plan-Do-Check-Action cycle approach to responding to customer feedback and evaluating the effectiveness of response measures.

“Autonomous Quality Pledge” Activities

1. Each and every employee is encouraged to consider how they provide satisfactory quality in their responsible area for their subsequent work processes.
2. Each employee is encouraged to remain continually conscious of the nature of his or her pledge.
3. The pledges are evaluated and renewed at three-month intervals.

A Quality Pledge Poster



Quality Month Activities

The NOC Group has designated November of each year as quality month with the aim of "improving quality consciousness" and is engaged in various activities, including those conducted with partner companies. The theme of quality month during FY 2005 was "working to improve quality consciousness by putting ourselves in customers' shoes and aiming to realize customer satisfaction." In line with this theme, the NOC Group and its cooperating companies implemented the following activities.

1. Slogan Contest and Poster Exhibition

The NOC Group solicited slogans related to quality and about 3,000 were received. Slogans were selected from among those that were related to the theme of quality month. In addition, to conduct activities closely related to each type of operation, each department and company selected its own slogan. During quality month, posters with the selected slogan were displayed to heighten awareness of quality.



A Quality Month Poster

2. Quality-Related Lecture Meeting

As another means of increasing quality consciousness among NOC employees, a lecture meeting was organized at which two speeches were made by employees of All Nippon Airways Co., Ltd. (ANA), a company that makes focusing on customer desires a principal focus of its management operations. Mr. Hironari Takagi, captain, of the Planning & Administration Section of ANA's CS Promotion Department, presented a speech entitled "ANA's Brand Strategy—Customer Satisfaction Is the Starting Point," and Ms. Yasuko Hayashi, of ANA's Inflight Services Department, presented a speech entitled "Boosting Quality in the Passenger Cabin Operations—Aiming for Quality Levels that Impress/Delight." This meeting helped to promote the understanding of quality improvement from the customers' perspective.

3. Quality Quizzes

To deepen knowledge related to the role of quality in improving relationships with customers, NOC provided an e-learning course, such as quizzes on the themes of "NOC Group products," "quality from the customers' perspective," and "the quality of petroleum products."

Quality Consciousness as a Means of Realizing Customer Satisfaction (Example)

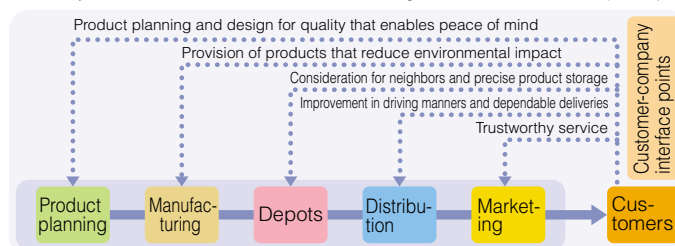

FY2006 Quality Assurance Policies

Aiming to win customer satisfaction with all the products and services that the NOC Group units manufacture or market, we are proceeding with quality assurance activities during FY 2006, with emphasis on the following policies.

1: Thorough Measures to Prevent Problems and Complaints before They Happen

Issues related to quality assurance and control in each stage will be newly identified. Customer complaints are to be prevented by means of thorough efforts by employees at each operational stage to completely eliminate quality problems.

2: Improving Service Quality

We will work to gain a better understanding of customers' needs and expectations and then work to improve the quality of our services through programs based on the Plan-Do-Check-Action cycle.

NOC Receives Award from TOYOTA

NOC received the TOYOTA Award for Technology & Development for its Automatic Transmission Fluid (ATF), which was developed jointly with TOYOTA MOTOR CORPORATION, at the 2004 TOYOTA Global Supplier Conference. This is the first time that an oil company has been the sole recipient of one of these awards. NOC was recognized because of the high degree of difficulty involved in developing ATF, which on its own improves fuel economy by more than 1% and therefore contributes to TOYOTA's efforts to improve the fuel efficiency and lower CO₂ emissions of its automobiles.



Nippon Petrochemical: Obtained ISO 9001 Certification from Manufacturing through Sales

Nippon Petrochemical obtained its first ISO 9001* certification in 1995 for the Kawasaki Operations Center. In addition, in 2003, all groups of the SCM Center of Nippon Petrochemical's headquarters, which is that company's logistics division, and in 2004, the marketing groups in charge of sales, obtained ISO 9001 certification.

* A certification based on international standards for quality control and quality assurance issued by the International Organization for Standardization.

CSR Initiatives at Service Stations

ENEOS-brand service stations numbered approximately 11,000 as of March 31, 2005. In addition to the sale of gasoline and other petroleum products, ENEOS service stations also provide car wash, automobile safety check, oil change, and vehicle inspection services to assist customers in taking optimal care of their automobiles. Since service stations are the key interface point between NOC and its customers, NOC pays careful attention to ensuring that its service stations provide top-quality service to promote customer satisfaction and confidence.

● Environmentally-friendly Products

ENEOS service stations offer many products that reflect NOC's concern for the environment. These include premium gasoline, which meets environmental regulations in advance of their implementation, sulfur-free gasoline, sulfur-free diesel fuel, and fuel-saving motor oil. (Page 22)

● Listening Carefully to Our Customers

We have established a Customer Consultation Office and we are using their valuable opinions to improve our services. (Page 12)

● Barrier-free Spaces

NOC is moving forward with the installation of rest rooms and sloping entrances that facilitate the use of wheel chairs and service rooms that can meet the needs of a broad range of customers, including the physically challenged and senior citizens.

● Preventing Electrostatic-caused Accidents

Since gasoline can be ignited even with a tiny spark due to static electricity, NOC has installed static electricity prevention sheets on all fuel dispensers at its self-service stations. In addition, service station staff wear uniforms treated to prevent static electricity.

● Preventing Fuel Contamination

To prevent the mixture of oil due to errors in unloading petroleum products into wrong storage tanks, NOC has introduced electronic control systems.

● Preventing Soil Contamination

To prevent soil contamination, NOC has been installing double-walled storage tanks at its service stations. In addition, NOC conducts soil surveys deliberately, and if contamination is discovered, takes appropriate measures. (Page 27)

● Disaster Measures

Since service stations handle gasoline and other hazardous materials, full measures are taken to ensure resistance to damage due to earthquakes and fire. In addition, some ENEOS service stations, named "Disaster-Ready Service Stations," have their own electric power generators and water storage tanks. They are ready to continue to provide energy and water to members of the community following natural disasters when electric power, gas, and other "lifeline" utilities may not be operational.





● High Value-added Service

NOC's high value-added service stations are equipped to provide car care services that include diagnoses and advice from professional staff. In addition to regular maintenance services, these outlets also provide vehicle inspection services and their motto is "act as the physician for our customers' automobiles and to be the place where reliable and pleasant driving starts." The number of ENEOS service stations providing high value-added services had increased to about 2,000 as of March 31, 2005.

● Hydrogen Stations

Work is well under way to commercialize vehicles powered by fuel cells, and filling stations for hydrogen will be needed in the future. NOC already has one experimental hydrogen station in operation in Yokohama and is committed to contributing to supporting the use of fuel cell vehicles and building the hydrogen supply infrastructure. (Page 24)

● Fuel Cells

In addition to providing hydrogen for fuel cell automobiles, NOC is considering the installation of fixed fuel cell generators that will supply electricity and hot water to the surrounding community. (Pages 23 and 24)

● Training of Service Station Staffs

To win the trust and confidence in the ENEOS brand, NOC believes that continually improving the quality of service station staff is essential. Accordingly, NOC conducts a wide range of training courses to support the training of staff employed at the service stations operated by dealerships and sales companies.

● ENEOS Card

ENEOS cards can be used not only for making payments but also to obtain service on the road and other premium services that give drivers peace of mind and support their driving experience. Moreover, 0.01% of the total payments made by customers using their ENEOS cards at service stations is donated to the National Land Afforestation Promotion Organization to support their activities to protect valuable forestlands. (Page 31)

● Protection of Personal Information

The NOC Group is working to protect personal information. Activities include the distribution of the *ENEOS Personal Information Protection Guidebook* and other related manuals. (Page 11)

● indicates the following activities.

- Compliance is always conducted in all service station operation.
- Information security related activities
- Quality assurance related activities
- Environment and safety related activities
- Activities contributing to society
- Activities related to respect for human rights and dignity



Environmental Management

To sustain steady progress in the implementation of its environmental management, the NOC Group has created environmental management systems and gives consideration to the environment in all its activities.

The NOC Group Environmental Vision

The NOC Group has positioned “environmental harmony” as one of the key themes of its group philosophy.

In 2003, we adopted the NOC Group Environmental Vision for the purpose of contributing to the creation of a sustainable society*.

*A sustainable society is an ethical society that protects the natural environment while sustaining economic prosperity, and is thereby able to continue developing into the future

Vision 1—

The NOC Group is aware that creating a sustainable society is its social mission and gives consideration to the environment in all its activities.



Vision 3—

We will develop energy technologies that are in harmony with the natural environment and encourage the transition to new sources of energy, while working to build a diversified energy infrastructure.

Vision 2—

We will foster a culture that uses products that have less impact on the natural environment and use energy more efficiently.

Environmental Management System

Accompanying the reform of the CSR promotion system in June 2005, the NOC Group Environment and Safety Committee was established under the CSR Committee.

This committee is responsible for drafting medium-term environmental management plans, strengthening the Group’s environmental management systems, and considering various other measures related to the environment.

Expanding the Scope of ISO 14001 Certification

Since April 1996, when the Negishi Refinery became the first petroleum industry facility in Japan to obtain ISO 14001 certification, the NOC Group has proceeded to obtain additional certifications, primarily for manufacturing facilities with significant environmental impact.

Reflecting the further strengthening of its environmental management systems, NOC obtained ISO 14001 certification in March 2005 for its Headquarters and Central Technical Research Laboratory. Currently, such certification has been obtained for 24 facilities of 12 NOC Group companies.

During FY 2006, NOC plans to introduce environmental management systems at all its branches and obtain ISO 14001 certification. To continue the expansion of environmental protection programs throughout the NOC Group, plans call for obtaining ISO 14001 certification for the Headquarters of NOC Group companies during FY 2006 or subsequently.

Environmental Education Programs

NOC in FY 2005 began offering environmental education courses using e-learning system for employees at its Headquarters and Central Technical Research Laboratory.

The improvement of environmental education programs is intended to deepen the environmental consciousness of each individual employee and thereby help promote the reduction of environmental impact both within and outside the Company from its operations.

The Importance of Oil Remains Unchanged

Compared with other sources of energy, the use of oil is superior in terms of convenience and efficiency because of (1) various usage, (2) easiness of storage and transport, and (3) a nationwide supply infrastructure. Oil is, therefore, indispensable for our daily lives. Currently, half of Japan’s primary energy is provided by oil. The importance of oil will remain unchanged and continue to account for the largest share of primary energy in the years ahead. (The percentage of primary energy provided by oil is expected to be around 40% in 2030 by the Advisory Committee for Energy.)

Oil is also a reliable energy source even in times of disaster. At the time of the Niigata Chuetsu Earthquake in October 2004, of the 358 service stations in cities and towns that experienced a magnitude 5 or greater during the tremor, 346 were able to use their in-house power generators, hand pumps, and other means to continue supplying gasoline, kerosene, and other petroleum products even though electric power, gas, and other “lifeline” utilities were not operational.

In addition, oil is evolving into a clean source of energy. The NOC Group was the first petroleum product supplier in the world to offer sulfur-free gasoline and diesel fuel, and it has developed and begun to market fuel cell systems using LPG and kerosene. Through these activities, the NOC Group is actively contributing to reduction in CO₂ emissions and the prevention of atmospheric pollution.

Medium-Term Environmental Management Plan

The NOC Group has prepared its Medium-Term Environmental Management Plan (FY 2006 to 2008) for implementation in tandem with its Third Medium-Term Consolidated Management Plan and is continuing its efforts to reduce the environmental impact of its activities.

Principal Achievements and Objectives under the Medium-Term Environmental Management Plan

Principal Theme	Main Objectives	Main Achievements of FY 2005	Main Targets of FY 2006 - FY 2008
Establishment of environmental management systems (Page 17)	Expand the scope of obtaining ISO 14001 certifications	Obtained certifications for the NOC Headquarters and Central Technical Research Laboratory	Obtain ISO 14001 certifications throughout the NOC Group
Environmentally-friendly products and services (Pages 22 to 25)	1. Expand sales of environmentally-friendly products and services		
	■ Automobile fuels	● Nationwide marketing of new premium gasoline* ¹ ● Began sales of sulfur-free gasoline and diesel fuel	Increase sales of new premium gasoline Increase sales of sulfur-free gasoline and diesel fuel
	■ Environmentally-friendly lubricants	● Began sales of new environmentally-friendly lubricants	Increase sales of environmentally-friendly lubricants
	■ Petroleum cogeneration systems	● Increased sales of petroleum cogeneration systems	Promote ESCO business* ²
	2. Development and promotion of new energy sources		
	■ Fuel cells	● Commercialization of household fuel cells using LPG	Commercialization of fuel cells using kerosene
■ Wind power generation	● Considered new business initiatives	Promote business activities	
■ LNG	● Established integrated operation from exploration to sales	Promote LNG business activities	
Activities to reduce the environmental impact (Pages 26 to 28)	1. Global warming prevention measures		
	(1) Energy conservation at refineries ■ Specific energy consumption at refineries	● Reduced 18.4% compared with FY 1991	Continue to reduce an average of 1% per year (Goal to reduce 20% from FY 1991 levels by FY 2011)
	(2) Application of the Kyoto mechanism ■ Project for effective use of gases generated during production at the Rang Dong Oil Field in Vietnam	● Promoted Clean Development Mechanism (CDM)	Register as CDM with UN organization and issuance of certified emission reductions
	■ Carbon fund	● Participation in JGRF* ³	Make use of the World Bank's CDCF* ⁴ and JGRF
	2. Soil contamination countermeasures		
	■ Promotion of surveys and countermeasures	● Implement surveys and suitable measures (Surveys: 397; Measures: 51)	Complete surveys in progress at NOC and NPRC by FY 2007* ⁵
	■ Soil remediation technology	● Evaluation of current technologies	Develop new on-site remediation technologies* ⁶
	3. Measures to reduce waste* ⁷		
■ Reduced industrial waste of 89% compared with FY 1991* ⁸	● Reduced industrial waste of 89% compared with FY 1991* ⁸	Achieve zero emissions at NPRC	
4. Reduction of environmental impact in office			
■ Began operation of system for tracking paper usage	● Began operation of system for tracking paper usage	Reduce electric power, paper, and waste for final disposal* ⁹	
Other environmental activities (Page 18 and pages 31 to 33)	1. Green procurement		
	■ Priority purchase of environmentally-friendly products, etc.	● Priority purchase of environmentally-friendly products, etc.	Achieve the ratio of green purchases to 100%
	2. Environmental contribution activities		
	■ Donations to the National Land Afforestation Promotion Organization	● Approximately 20 million yen	Continue donations
■ Creation of 'ENEOS Forests'	● One location (Kanagawa Prefecture)	Expand to six locations nationwide	
■ Implementation of environmental education programs	● One location (Osaka Refinery)	Expand to six locations nationwide	

*1 Excludes Okinawa Prefecture and certain islands *2 Energy Service Company. ESCO is a business that provides energy management services. *3 Japan GHG Reduction Fund *4 World Bank Community Development Carbon Fund *5 The NOC Group is conducting systematic surveys at service stations owned by dealerships. *6 On-site remediation technologies for contaminated soil *7 Goal of having 17 NOC Group companies achieve zero emissions by FY 2011 *8 Actual results for NPRC. *9 Reduce electric power by 3%, paper usage by 10%, waste for final disposal by 20% (Goal for NOC Headquarters building and a part of the NOC Group in FY 2008)

Promoting Green Procurement

The NOC Group is promoting green procurement throughout its entire supply chain to effectively reduce the environmental impact of its activities on a continuing basis.

1. Green purchasing

The NOC Group is giving priority to buying environmentally-friendly products for the office and other uses and its introducing low-emission vehicles. In FY 2006, the NOC Group will expand the range of green items and raise the ratio of green purchases to 100% by FY 2008.

2. Use of green materials and other items

The NOC Group is engaged in initiatives to prevent the use of materials for manufacturing, etc., that contain harmful substances from outside sources.

3. Purchasing from green suppliers

The NOC Group is working in partnership with its suppliers to reduce the impact of its activities on the environment on a continuing basis. In FY 2005, we secured the cooperation of certain suppliers to respond to a questionnaire regarding environmental initiatives, and the results will be used in formulating guidelines.

Overview of the NOC Group's Environmental Impact

INPUT

	FY 2004	FY 2005	Change
Electricity(Million kWh)	0.8	1.1	0.3
Fuel (1,000 kl ¹)	47	175	128
Water(1,000 tons)	—	12	—
Seawater(Million tons)	—	62	—

¹ Crude oil equivalent

INPUT

	FY 2004	FY 2005	Change
Electricity(Million kWh)	17	24	7
Fuel (1,000 kl ¹)	606	208	-398
Water(1,000 tons)	84	108	24
Seawater(Million tons)	411	129	-282

INPUT

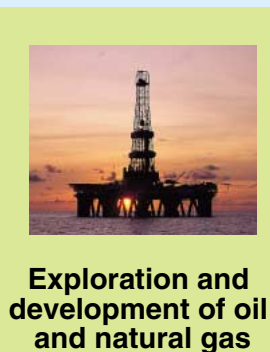

Exploration and development of oil and natural gas

- Nippon Oil Exploration Limited^{*2}

Crude oil (purchased)

FY 2004	60.23 million kl
FY 2005	61.75 million kl
Change	1.52 million kl

Crude oil and condensate(Shipments)^{*3}

FY 2004	3.16 million kl
FY 2005	3.59 million kl
Change	0.43 million kl

Gas (Shipments)^{*4}

FY 2004	0.8 billion cubic meters
FY 2005	2.8 billion cubic meters
Change	2.0 billion cubic meters



Transportation

- Nippon Oil Tanker Corporation^{*5}

Storage

- Nippon Oil Staging Terminal Co., Ltd.
- Okinawa CTS Corporation
- Shibushi Oil Storage Co., Ltd.^{*6}
- Kamigoto Oil Storage Co., Ltd.^{*6}

^{*2} INPUT/OUTPUT are based on data of Japan Vietnam Petroleum Co., Ltd. and Nippon Oil Exploration(Malaysia) Limited.

^{*3} Data of Japan Vietnam Petroleum Co.,Ltd.

^{*4} Data of Nippon Oil Exploration (Malaysia) Limited

^{*5} Figures for FY 2004 included the data of a company out of the NOC Group, which is excluded from the figures for FY 2005.

^{*6} The two companies have newly been included to the scope of figures.

OUTPUT

	FY 2004	FY 2005	Change
CO ₂ ^{*8} (1,000 tons)	820	1,033	213
SOX (tons)	150	160	10
NOX (tons)	1,146	1,540	394
Dust (tons)	3	30	27
COD (tons)	—	90	—
Final waste disposal ^{*9} (tons)	25,552	26,250	698

^{*8} Includes leakage of methane gas

^{*9} Since FY 2005, includes not only industrial but general waste

OUTPUT

	FY 2004	FY 2005	Change
CO ₂ (1,000 tons)	1,660	575	-1,085
SOX (tons)	14,631	10,564	-4,067
NOX (tons)	47	38	-9
Dust (tons)	5	6	1
COD (tons)	0.1	0.2	0.1
Final waste disposal ^{*9} (tons)	486	430	-56
VOC (Benzene) (tons)	1	1	0
(Toluene) (tons)	1	2	1
(Xylene) (tons)	22	23	1

	FY 2004	FY 2005	Change
Electricity(Million kWh)	264	246	-18
Fuel (1,000 kl ¹⁾)	4,847	5,028	181
Water(1,000 tons)	80,168	84,299	4,131
Seawater(Million tons)	591	603	12

INPUT



Refining Production

- Nippon Petroleum Refining Co., Ltd.
- Nihonkai Oil Co., Ltd.
- Nippon Petrochemical Co., Ltd.
- Nippon Petroleum Processing Co., Ltd.
- Wakayama Petroleum Refining Co., Ltd.

OUTPUT

	FY 2004	FY 2005	Change
CO ₂ (1,000 tons)	12,481	12,961	480 ^{*10}
SOx (tons)	7,450	5,850	-1,600
NOx (tons)	8,011	7,332	-679
Dust (tons)	557	571	14
COD (tons)	426	485	59
Final waste disposal ¹⁹⁾ (tons)	2,477	2,569	92
VOC (Benzene) (tons)	37	38	1
(Toluene) (tons)	106	111	5
(Xylene) (tons)	51	52	1

	FY 2004	FY 2005	Change
Electricity(Million kWh)	18	34	16
Fuel(1,000 kl ¹⁾)	212	297	85
Water(1,000 tons)	164	141	-23

INPUT



Distribution Sales

- Nippon Oil Co., Ltd.
- Nippon Petroleum Gas Co., Ltd.^{*7}

OUTPUT

	FY 2004	FY 2005	Change
CO ₂ (1,000 tons)	560	814	254
SOx (tons)	8	4	-4
NOx (tons)	13	4	-9
Dust (tons)	0.4	0.2	-0.2
COD (tons)	2	1	-1
Final waste disposal ¹⁹⁾ (tons)	161	219	58

INPUT Data

Electricity: Volume purchased from outside
 Fuel: Usage for in-house power generation and other uses
 Water: Usage of fresh water and industrial water
 Seawater: Usage of water from the sea

Products



Customers (Consumption)

Sales volume	FY 2004	FY 2005	Change
LPG (1,000 tons)	2,810	2,840	30
Gasoline (1,000 kl)	14,090	14,720	630
Naphtha (1,000 kl)	6,050	6,280	230
Jet fuel (1,000 kl)	1,220	1,210	-10
Kerosene (1,000 kl)	7,070	7,710	640
Diesel fuel (1,000 kl)	8,610	8,770	160
Fuel oil A (1,000 kl)	8,360	8,840	480
Fuel oil C (1,000 kl)	8,940	7,950	-990
Crude oil (1,000 kl)	2,120	2,050	-70
Barter and other (1,000 kl)	29,720	29,910	190

OUTPUT

	FY 2004	FY 2005	Change
CO ₂ (1,000 tons)	140,981	143,162	2,181

*10 CO₂ emissions increased because of an increase of oil processing quantity and facilities reinforcement for sulfur-free gasoline and diesel fuel. On the contrary, specific energy consumption at oil refineries has been decreasing less than the target of the voluntary action plan of the Petroleum Association of Japan as a result of energy saving.

Note: CO₂ emissions were computed according to the *Guidelines for Calculating Emissions of Greenhouse Gases by Businesses (Version 1.5)*, Ministry of the Environment.

Environmental Efficiency, Environmental Accounting

To evaluate the efficiency and effectiveness of environmental management, the NOC Group has introduced indicators of environmental efficiency and environmental accounting.

Integrated Evaluation of Environmental Impact

To provide a comprehensive evaluation from a diversity of environmental perspectives, the NOC Group conducts an integrated evaluation* of its impact on the environment.

The impact of the Group's petroleum business activities at the product consumption stage is declining, as a consequence of sales of low-sulfur gasoline and diesel fuel (Chart 1). On the other hand, to reduce the impact at the product consumption stage, an increase in the impact at the refining stage is unavoidable because of investment in equipment and other factors (Chart 2). However, through initiatives to reduce energy consumption, the Group strives to restrain the specific energy consumption at oil refineries. (Please refer to Page 26)

In addition, we have analyzed the relationship between the environmental impact and the volume of production of the Group's petroleum business to provide an evaluation of overall environmental efficiency. This evaluation shows that environmental efficiency is improving consistently (Chart 3).

* The evaluation was made using the LIME method of AIST (National Institute of Advanced Industrial Science and Technology).

Outline of Environmental Accounting

The Group has introduced environmental accounting as a tool to evaluate the efficiency and effectiveness of environmental management and as a disclosure tool. The Group uses the environmental information management system introduced in FY 2004 to gather data efficiently and conduct centralized supervision of data. In FY 2005, environmental investment amounted to 20.4 billion yen for the introduction of energy-saving and other equipment, and the environment expense amounted to 106.8 billion yen for the operation of environment-related equipment.

Content of principal sub-categories

- * 1 Energy-saving and introduction of new energy equipment. Surveys and study of policies for reducing CO₂ emissions.
- * 2 Development of gasoline and diesel fuel that emit lower NO_x, PM, and other substances in vehicle emissions. Promotion of environmentally-friendly business activities (Development of fuel cells, expanding use of oil cogeneration systems, development and introduction of renewable energy equipment). Development of environmentally-friendly lubricants, etc.
- * 3 Voluntary surveys and measures for soil contamination
- * 4 Activities to reduce the amount of waste for final disposal (use of recycled drum cans and other materials), environmental contribution activities, green purchasing.
- * 5 Flue gas desulfurization and denitrification, dust removal equipment, wastewater treating equipment (eliminating oil and COD), noise and vibration reducing equipment.
- * 6 Outsourcing of waste processing
- * 7 Maintenance of green belts in according with environmental laws and administrative guidance
- * 8 Daily environmental management (personnel expenses of the environmental department, ISO 14001 certification, purchase of books, etc.)
- * 9 Gasoline, diesel fuel, and heavy oil desulfurization equipment (reducing sulfur content of products), gasoline quality increasing equipment (increasing octane number, removal of benzene, etc.)
- * 10 Soil surveys and measures for soil contamination in accordance with environmental laws and administrative guidance
- * 11 Levies for pollution impact under the Law Concerning Pollution-Related Health Damage Compensation and Other Measures

Chart 1: Total Environmental Impact (Exploration + transportation + refining + consumption)

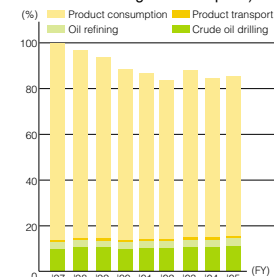

Chart 2: Total Environmental Impact in Refining

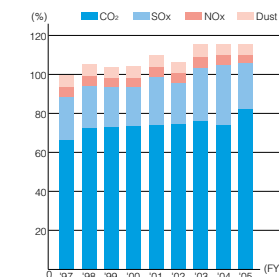
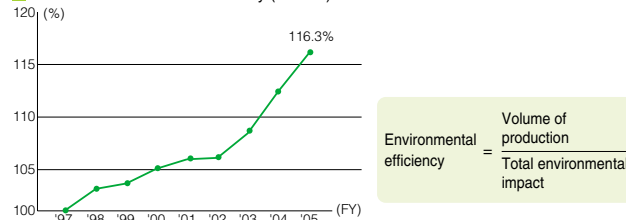

Chart 3: Environmental Efficiency (Overall)



Environmental Accounting for FY 2005

(Billion yen)

	Major category	Sub-category	FY 2004	FY 2005
Environmental Investments	Target management	Measures to prevent global warming *1	3.6	0.5
		Environmentally-friendly products development *2	0.8	1.9
		Surveys and measures for soil contamination *3	-	-
		Measures for waste treatment *4	0.2	0
	Compliance	Pollution prevention *5	19.9	14.1
		Waste treatment *6	-	-
		Green belts, etc. *7	0.3	0
	Internal management	Daily management *8	-	-
		Environmental measures for products *9	3.2	3.9
	Environmental remediation	Surveys and measures for soil contamination *10	-	-
		Levies for pollution *11	-	-
		Total	28.0	20.4
Environmental Expenses	Target management	Measures to prevent global warming *1	5.3	5.2
		Environmentally-friendly products development *2	7.1	8.0
		Surveys and measures for soil contamination *3	2.7	1.4
		Measures for waste treatment *4	2.7	2.8
	Compliance	Pollution prevention *5	17.0	19.7
		Waste treatment *6	1.4	1.5
		Green belts, etc. *7	0.5	0.6
	Internal management	Daily management *8	1.3	1.4
		Environmental measures for products *9	64.9	64.6
	Environmental remediation	Surveys and measures for soil contamination *10	0.1	0.4
		Levies for pollution *11	1.1	1.2
		Total	104.1	106.8

Premium Gasoline

The NOC Group is working to develop and market high-quality fuels to reduce atmospheric pollutants and greenhouse gases emitted from automobiles.

Environmentally-friendly Premium Gasoline

New premium gasoline, which NOC began to supply in January 2005, is an environmentally-friendly premium gasoline that features guarantee of sulfur-free and blend of friction modifier, plus the most advanced engine-cleaning performance in Japan.

Features

New functions

Most advanced engine-cleaning performance in Japan

Includes a new high-performance detergent that reduces air valve grime **86%** and lowers exhaust emissions of regulated gases a maximum of **10% to 30%**

Conventional functions

Blend of friction modifier

Fuel economy improvement up to **3%**
Acceleration improvement up to **5%**

Sulfur-free guarantee

Preoccupation of future environmental regulations

Through the inclusion of a new, high-performance detergent, the new premium gasoline has improved cleaning features that exceed the cleanup capabilities of the previous premium gasoline. Therefore, the new premium gasoline makes it possible to clean 86% of the grime that accumulates on engine air valves. As a result, it contributes to reducing regulated emission gases (CO, HC, and NOx) by a maximum of between 10% and 30%.

Engine-cleaning function

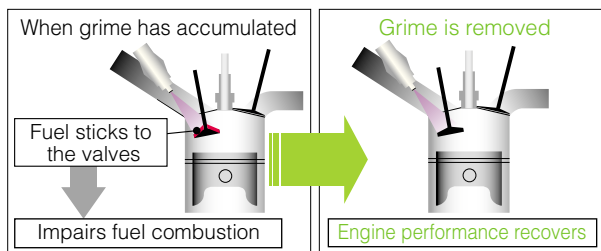

Reduction in Emission Gases

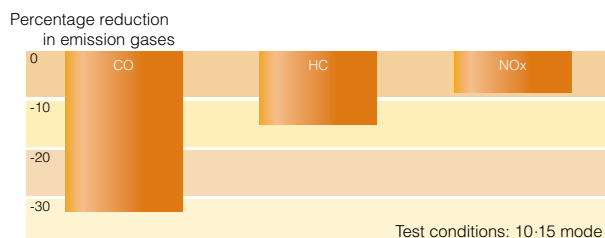

Also, since the new premium gasoline contains a friction modifier, fuel economy is improved up to 3% (reducing CO₂ emissions) or acceleration is increased up to 5%. NOC markets the new premium gasoline nationwide in Japan (with the exception of certain islands) as of July 1, 2005. And it has received a highly favorable evaluation.

Sulfur-Free Automobile Fuels

NOC has developed sulfur-free* automobile fuels in advance of future environmental regulations and, in January 2005, began to supply sulfur-free regular gasoline and diesel fuel. These sulfur-free fuels not only reduce atmospheric pollution but also make it possible for automobile manufacturers to install new engines with dramatically improved fuel economy and reduce emissions of CO₂. In addition, sulfur-free diesel fuel substantially improves emission gas conditions and contributes to the wider use of diesel engines, which offer superior fuel economy.

* Sulfur-free means the sulfur content in gasoline and diesel fuel is 10ppm or less. ppm, or parts per million, is a measure of content, and 10ppm is 0.0010%.

Sulfur Content of Gasoline and Diesel Fuel Compared with Anticipated Regulations

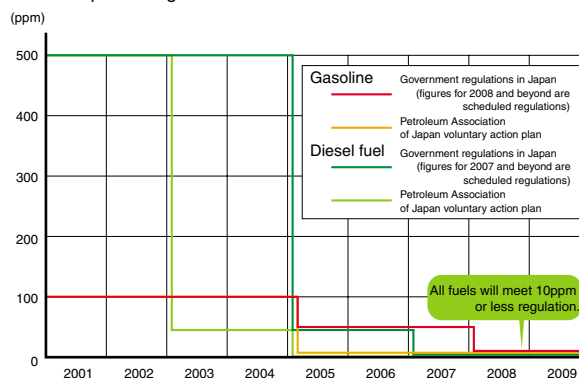

Petroleum Association of Japan (PAJ) Receives Tokyo Metropolitan Environmental Award (the Governor's Award)

The members of PAJ began to supply sulfur-free gasoline and diesel fuel with sulfur content of 10ppm or less. Their proactive stance toward addressing environmental issues has been highly appraised, and PAJ received the 2005 Tokyo Metropolitan Environmental Award (the Governor's Award). This is the second time for PAJ to be honored, as it also received the Governor's Award in 2002 for early introduction of diesel fuel with sulfur content of less than 50ppm.



President Watari holds the testimonial and commemorative medal.



Fuel Cells

The NOC Group has commercialized the world's first household fuel cell system using LPG. The Group proposes these fuel cell systems for a comfortable lifestyle that is in harmony with the environment.

Principle of Fuel Cell System

Fuel cells generate electricity by reversing the process of water electrolysis. Since there is hardly any hydrogen as a natural resource, it must be produced from petroleum, LPG, natural gas, or other hydrocarbons. Fuel cells do not burn hydrogen, but create electric energy directly through electrochemical reactions that are more efficient than conventional power generation methods. In addition, fuel cells greatly reduce emissions of CO₂, which causes global warming, and SO_x and NO_x, which pollute the atmosphere. Moreover, the heat generated by reactions in fuel cells can be recycled for use in quiet and efficient cogeneration systems.

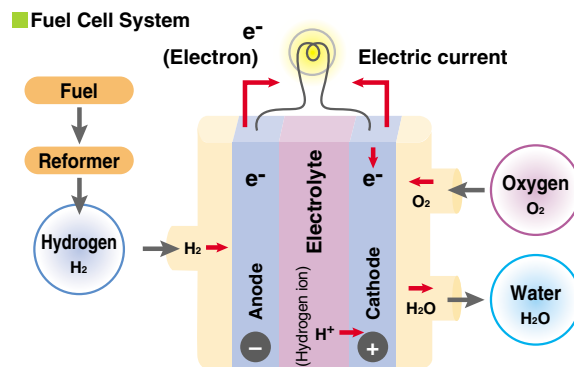

Commercialization of the World's First Household Fuel Cell System Using LPG

NOC has been improving a household fuel cell system using LPG based on the data and other information accumulated during the monitor testing nationwide since 2003 and marketed the system for the first time in the world in March 2005. The cogeneration system uses LPG to generate both electric power and hot water, and is an environmentally-friendly product with a high 76% level of overall energy efficiency. Plans call for installing 150 household fuel cell units during FY 2006, primarily in Tokyo and 10 prefectures near Tokyo, then undertaking nationwide marketing from FY 2007.

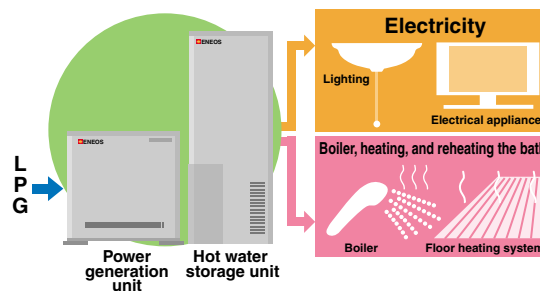

NOC is also pilot testing business-use and household-use fuel cell systems that use kerosene and undertaking R&D activities aimed at enabling the commercialization of those products in the near future.

The Household Fuel Cell System Using LPG's Specifications

Rated power output	750W	Hot water tank volume	200 liters
Power generation efficiency	34% (LHV*)	Heat-recovery ratio	42% (LHV*)

(Power generation unit: 1.0m wide, 1.0m tall, 0.45m deep
Hot water storage unit: 0.75m wide, 1.9m tall, 0.44m deep)

* Lower heating value (LHV) represents the net calorific value of fuels calculated by subtracting latent heat recovery due to the condensation of steam generated during combustion from the total calorific value.

Four Merits of the Household Fuel Cell System Using LPG

Environmentally-friendly

Approximately 30%-40% reduction of CO₂ emissions

Thermal power generation + Conventional hot water supply system
Household fuel cell cogeneration system

Efficient, energy-conserving design

An energy efficiency rate (76%) that is approximately twice that of conventional electricity supply systems

Conventional systems: Power plant → Electricity (35~40%), Transmission loss 5%, Unused waste heat 55~60%
Fuel cell system: Fuel cell → Electricity (70~80%), Heat (hot water), Waste heat that is difficult to use 20~30%

Reduction of lighting and heating expenses

Overall reduction of lighting and heating expenses by approximately 20% or more

Annual running cost savings from the introduction of fuel cell system using LPG (Example of an estimate)*
300,000 yen (Before introduction) vs. 200,000 yen (After introduction)

Reliable in times of disasters

Use of on-site LPG tanks enables quick recovery following disasters (that affect power and gas lines)

Recovery of "Lifelines" following the Great Hanshin Awaji Earthquake
(1,000 service outages)
1,200 (LPG), 1,000 (Town gas), 1,000 (Electricity), 600 (Water), 800 (Community gas)

Lifestyle with Fuel Cell System

The efficient design of NOC's fuel cell system enables effective power and heat supply in line with households' lifestyles.

Fuel Cell System

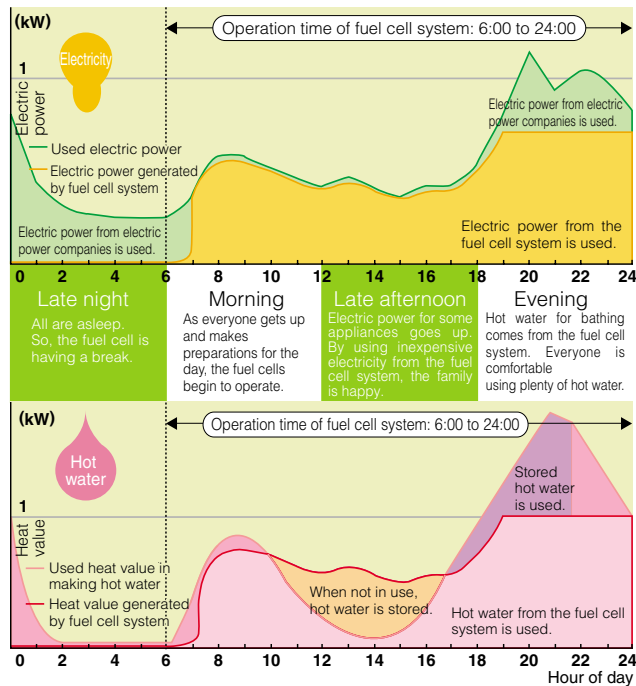

Fuel Cell Systems using LPG Displayed in the Global House at Expo 2005 Aichi

The Group is providing three fuel cell systems using LPG at the 2005 World Exposition, Aichi, Japan (Expo 2005 Aichi). Two systems installed by the entrance of the theme pavilion of the Japan Association for the 2005 World Exposition, Global House, provide electric power to drive NOC's two exhibits. Another system installed by the exit of the Mammoth Laboratory meets a portion of the electric power requirements of the Global House.

Application to Automobiles

As a participant in the Japan Hydrogen & Fuel Cell Demonstration Project (JHFC), which is organized by the Ministry of Economy, Trade and Industry, and aims to demonstrate the viability of hydrogen-powered fuel cell vehicles driven on public roads, NOC has installed and is operating the JHFC Yokohama Asahi Hydrogen Station in Yokohama. This hydrogen station supplies hydrogen produced from naphtha and serves as a base for research related to the creation of a commercial hydrogen supply infrastructure for fuel cell vehicles.

Having leased a fuel cell vehicle from TOYOTA MOTOR CORPORATION, the NOC Central Technical Research Laboratory is actively using the vehicle to conduct demonstration testing of the hydrogen supply infrastructure at its hydrogen station. NOC will continue to perform the R&D work necessary to create a commercial hydrogen supply infrastructure for fuel cell vehicles.



Fuel cell vehicle



"JHFC Yokohama Asahi Hydrogen Station", which supplies hydrogen to fuel cell vehicles demonstrating their viability driven on public roads

Environmentally-friendly Products and Services (3)

LNG, Wind Power and Cogeneration

Through the expansion of its operations related to LNG, wind power, and diverse types of cogeneration systems, the NOC Group is working to provide environmentally-friendly energies.

LNG Business

Natural gas is a clean energy source that emits no SOx and less amounts of NOx and CO₂ when burned. The volume of global natural gas reserves is substantial, and they are more evenly dispersed throughout the world. When cooled to -162°C, natural gas becomes liquefied natural gas (LNG), which can be efficiently transported in ships and stored in special tanks. In recent years, these characteristics have attracted increasing attention to natural gas as a promising source of energy.

The NOC Group has its own natural gas fields in Malaysia and Indonesia. In Malaysia, the Group has become the first Japanese company to establish integrated operations from natural gas resource exploration and development through LNG production and marketing, and it is using those capabilities to supply LNG to electric power companies, gas companies, and other customers in Japan and other countries. The Group also plans to begin producing LNG in Indonesia from FY 2009.



Helang gas field off the coast of Sarawak, Malaysia

Wind Power

The Group is generating energy by harnessing the natural energy of wind. A 1,500kW wind power generation unit installed at the Akita Oil Depot is being used to meet the internal power requirements of that depot and sell power to Tohoku-Electric Power Co., Inc. Besides responding to the Law on Special Measures for the Utilization of New Energy etc., which was put into force entirely in April 2003, the Group is continuing to assess wind conditions at Group facilities and study the further expansion of clean wind power energy business.



Wind power generation unit at the Akita Oil Depot

Expansion of Cogeneration Systems

Many of the customers of the NOC Group have installed cogeneration systems*¹ that make it possible to conserve energy and reduce CO₂ emissions. The NOC Group has accumulated strong technological capabilities as a result of its many years of experience in developing and installing these systems, and it offers a fully integrated set of services. These include design, construction, operational support, and maintenance. Moreover, the NOC Group makes proposals for its Total Energy System (TES) that comprises energy conservation systems and equipment (including commercial air-conditioning systems powered by kerosene and far infrared heaters) that can be tailored to the needs of individual customers.

From now on, the NOC Group continues to promote its ESCO business*² in response to diverse customer needs.

*¹ Energy systems that generate electric power and heat at the same time. Energy usage efficiency of cogeneration systems is 75%, compared to 52% for conventional systems. These systems find application in shopping centers, factories, hotels, and other installations.

*² Energy Service Company. ESCO is a comprehensive service that offers energy conservation without the loss of previous convenience. A portion of energy-saving benefits realized by users are used to pay for these systems.

Mechanism of petroleum cogeneration system

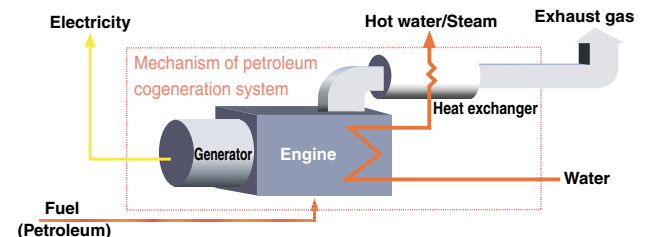

Cogeneration system at Shibayama factory of Nisseki Plasto Co., Ltd.

Activities to reduce the environmental impact (1)

Global Warming Prevention Measures

The NOC Group is promoting global warming prevention measures by reducing energy consumption in the manufacturing division and using the Kyoto mechanism.

Measures in Japan

Prevention measures in the refining division

The refining divisions of the NOC Group targets a 20% (average 1%/year) reduction of specific energy consumption* in FY 2011 compared to FY 1991, which is higher than that of Petroleum Association of Japan (PAJ) (a 10% reduction). The reduction rate in FY 2005 was 18.4%, which has already exceeded the target of PAJ.

*Evaluation method for energy conservation effect used commonly in the oil industry, calculated by dividing proceeded crude oil (1,000kl: Atmospheric-distilled oil equivalent) into energy consumption (kl: crude oil equivalent).

Specific energy consumption and energy consumption at oil refineries

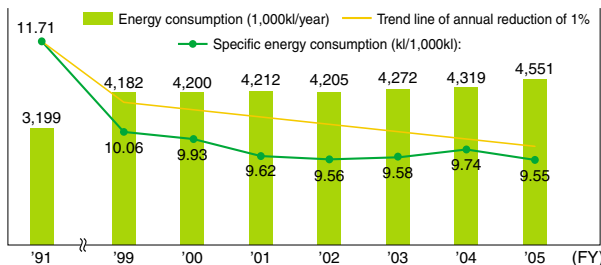

The NOC Group's oil consumption is increasing at oil refineries in line with the introduction of facilities to reduce sulfur content of gasoline and diesel fuel; however, our specific energy consumption is steadily decreasing due to energy conservation efforts.

CO₂ emissions and specific CO₂ emissions at oil refineries

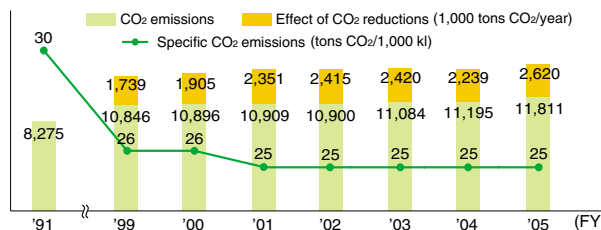

*After reviewing exhaust coefficient, we corrected the results for FY 2003 and 2004.

Transportation process measures

We are working to reduce the amount of fuel consumption through the optimization of our distribution processes. The NOC Group's FY2005 fuel consumption for land and marine transport was reduced by 56,000kl (a 23% reduction) for FY1991 levels, which is well within the goal for FY2011(a 9% reduction).

Fuel consumption for domestic shipping

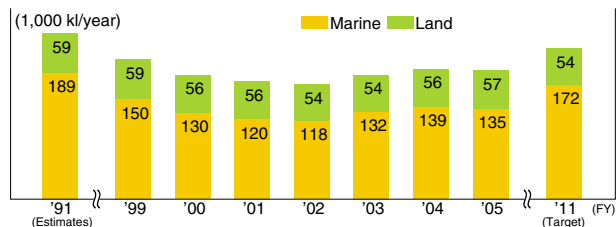

Measures Abroad

Effective utilization of associated gas at Vietnam's Rang Dong oil field

Off the southern shore of Vietnam at its Rang Dong oil field, Japan-Vietnam Petroleum Co., Ltd. (a subsidiary of Nippon Oil Exploration) had been flaring associated gas, which is generated as by-product of crude oil production. Since 2001, associated gas has been piped into the mainland and put to effective use, thereby enabling long-term reductions in CO₂ emissions. At present, we are submitting this scheme for application as a clean development mechanism (CDM) to the United Nations Framework Convention on Climate Change (UNFCCC).

CDM schematic diagram

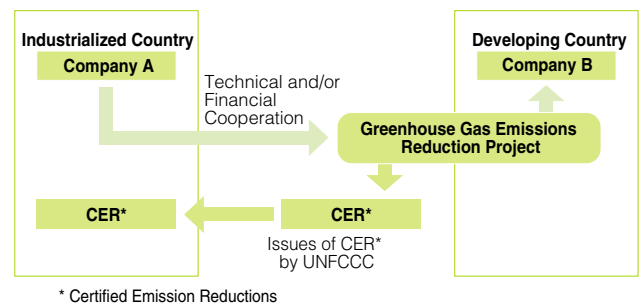

Participation in the World Bank Community Development Carbon Fund (CDCF)

NOC contributes to the World Bank Community Development Carbon Fund (CDCF). This fund supports small-scale projects (including wind, solar, and other renewable power sources) undertaken by developing countries to reduce greenhouse gas emissions by using contributions from CDCF participants, including governments of various countries and corporate investors. CER will be distributed to the investors in accordance with the CDM.

Participation in the Japan GHG Reduction Fund (JGRF)

NOC participates in the JGRF, which was established by Japanese corporations, the Japan Bank for International Cooperation, and the Development Bank of Japan as one of the largest sponsors. NOC also sponsors and dispatches a board member to Japan Carbon Finance, Ltd. (JCF), which procures CER for JGRF.

Activities to reduce the environmental impact (2)

Surveys and Countermeasures for Soil Contamination

To preserve the living environment, the NOC Group has established its own voluntary criteria and is conducting surveys and implementing countermeasures to deal with soil and groundwater contamination.

Basic Policy for Survey and Remediation of Soil and Groundwater

The NOC Group is conducting systematic surveys and remediation of all soil that could suffer from direct soil or groundwater contamination. "Guidelines for the survey and remediation of soil and groundwater," the base policy for addressing soil and contamination issues, was established in 2001. In addition to the basic substances specified in the Soil Contamination Countermeasures Law, the Group has voluntarily established its own criteria regarding oil contamination resulting from its principal business of petroleum product.

We are conducting surveys as needed at sites that are being closed or renovated and expect to complete surveys at sites owned by NOC and NPRC sometime by the end of FY 2007. Moreover, on sites owned by the NOC Group companies that appear likely to have the risk of contamination, we began surveys in FY 2006. Once a survey confirms that contamination exists, we implement appropriate countermeasures.

Results of surveys and countermeasures for FY 2005

The results of FY 2005 surveys and countermeasures are shown in the following table.

Category	Surveys		Countermeasures	
	Number	Expenses (million yen)	Number	Expenses (million yen)
Service stations	380	361	47	1,129
Oil depots	9	17	4	239
Refineries and other business sites	6	128	0	0
Others	2	15	0	0
Total	397	521	51	1,368

Further, contamination at the following sites exceeds the environmental standards, and the countermeasures prescribed by the guidelines are underway. We are implementing measures to quickly decontaminate these sites and are removing pollutants from them.

Category	Locations	Survey results				Countermeasures
		Soil		Groundwater		
		Substances	Multiplying factor (vs. standard value)	Substances	Multiplying factor (vs. standard value)	
Idle lands	Bihoro-cho, Hokkaido Pref.	Benzene	15	Benzene	150	Underway
	Sapporo, Hokkaido Pref.	Benzene	130	Benzene	670	Completed
	Oyama, Tochigi Pref.	Benzene	13	Benzene	35	Underway
	Osaka, Osaka Pref.	Benzene	9	Benzene	15	Underway
	Kuwana, Mie Pref.	Benzene	21	Benzene	19	Underway
	Kurashiki, Okayama Pref.	Benzene Lead (elution)	55 2	—	500 —	Completed
	Kurashiki, Okayama Pref.	—	—	Benzene	200	Completed
	Kushima, Miyazaki Pref.	Benzene	6,800	Benzene	5,500	Underway
	Nobeoka, Miyazaki Pref.	Benzene	220	Benzene	7,300	Underway
	Saga, Saga Pref.	Benzene	140	Benzene	3,800	Underway
Business sites	Kurashiki, Okayama Pref.	—	—	Benzene	3	Underway
	Kurashiki, Okayama Pref.	Benzene	2	Benzene	20	Underway
	Amagasaki, Hyogo Pref.	Benzene	2	Benzene	30	Underway

Soil Pollution Countermeasures

Green Search Co., Ltd. was established in October, 2002 through a joint partnership between NOC and NIPPO Corporation Co., Ltd. Green Search, which specializes in soil contamination survey and analysis, was established to improve and speed up soil survey and analysis.

From FY 2001, NIPPO Corporation began development on new remediation technologies to address contaminated soil and groundwater, which are applicable to almost any pollution problem. NIPPO Corporation is building infrastructure on its own initiatives that will enable it to offer proposals related to dealing with a wide variety of remediation needs.

The Soil Remediation Center has a heat remediation processing equipment, a widely used remediation technology, and equips special berths. They can convey contaminated materials for processing from anywhere in Japan in a ship.

Research and Development into Low-Cost Soil Remediation Technologies

From FY 2006, NOC began jointly researching and developing new remediation technologies with NIPPO Corporation with the goal of creating suitable low-cost technologies capable of treating contaminated soil.

Reformed Sulfur Solid

Sulfur recovered in the process of desulfurizing petroleum products can be mixed with such materials as iron and steel slag* and fly ash to create new types of materials that can be used in place of concrete. NOC has been moving ahead with the development of such reformed sulfur solid, which offers superior strength and impermeability to water as well as high levels of acid resistance. Reformed sulfur solid is an environmentally-friendly product to help recycle the by-products and waste products, such as oyster shell and other by-products, from various industries. With support from the Petroleum Energy Center, in August 2004, NOC completed the construction of a pilot plant at the neighborhood of the Muroran Refinery that has a production capacity of 70 tons per day. While manufacturing large-scale samples and conducting field testing of such samples, NOC is working to validate the profitability of this business. These materials were exhibited at the Eco-Products Exhibition 2004 held in Tokyo in December 2004.



Algal reef made from oyster shell, which is used as aggregate

■ Producing reformed sulfur solid

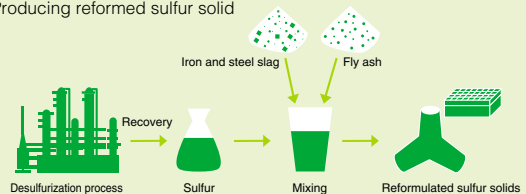

* Slag is a nonmetallic residue generated when metal ores are melted and refined in blast furnaces

Activities to reduce the environmental impact (3)

Waste Reduction Measures

The NOC Group is pursuing the reduction of waste and recycling activities that contribute to the formation of a recycling-based society.

Waste Reduction Activities

As part of its medium-term environmental management plan (FY 2006-2008), the NOC Group*¹ is further expanding its efforts to reduce waste and its activities to recycle materials, while taking steps to reduce waste (industrial waste and general waste) with the objective of zero emissions*² by FY 2011.

NPRC, which has a number of refineries that generate significant waste, is working to reduce the waste volume disposed at all of its seven refineries to achieve zero emissions by FY 2008, earlier than the Group target (FY 2011). NPRC has already achieved the Petroleum Association of Japan's FY 2011 target of a 67% reduction in the volume of industrial waste disposed compared to the FY 1991 level.

*1 Excluding Nippon Oil Exploration Limited and NIPPO Corporation Co., Ltd.

*2 The NOC Group's definition of "zero emissions": $\frac{\text{Waste volume disposed}}{\text{Waste volume generated}} < 1\%$

■ NPRC's Waste volume disposed and the ratio of waste volume disposed (industrial waste volume disposed/industrial waste generated)

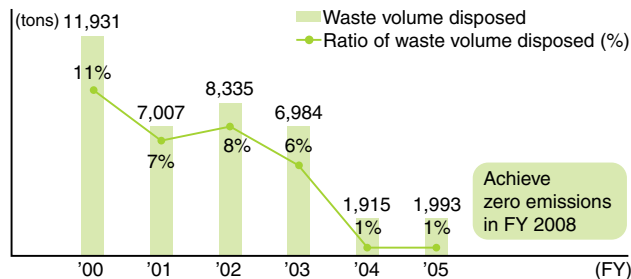

■ NPRC's waste treatment activities (FY2005)

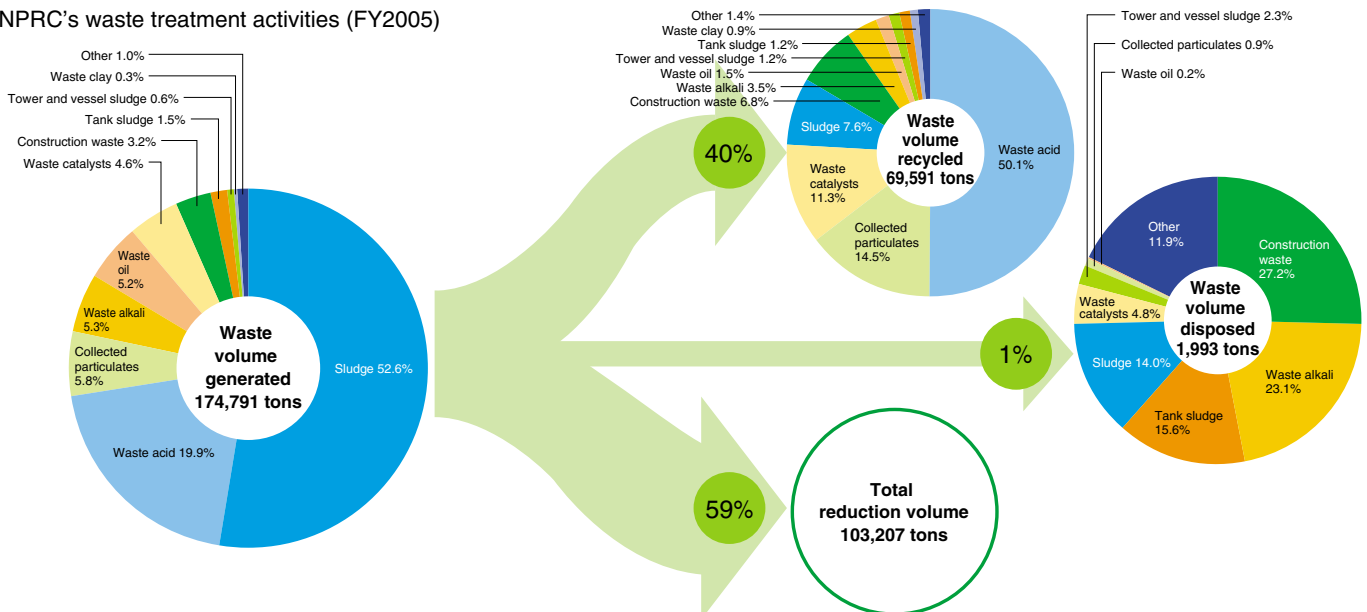

Waste Recycling Efforts at Refineries

Refinery waste includes sludge, waste catalysts, construction waste, and waste oil. These wastes are recycled in the following ways:

- 1.Sludge:** Sludge is discharged during the wastewater treatment process. After it is drained and dehydrated, it is then recycled and used mainly as a material for manufacturing cement.
- 2.Waste catalysts:** Catalysts, which are used for oil desulphurization, cracking, and other processes, become waste after losing the catalytic activity. These waste catalysts include useful metals, such as molybdenum and vanadium, and thus are collected as much as possible and then recycled.
- 3.Construction waste:** Waste generated from the renovation or leveling of buildings is recycled in roadbed material and other applications after separating the waste.
- 4.Waste oil:** Waste oil is recycled in roadbed material and other applications after thermal recycling*.

*The waste is not merely incinerated; energy generated during the incineration process is recovered and reused in power generation and other applications.

Waste Risk Management

In order to lower the risk of the illegal dumping of waste by firms, the Group has outsourced its waste disposal operations. The Group routinely selects appropriate firms and holds audit inspections.

Ensuring Safety

The NOC Group is working constantly to strengthen its measures for preventing accidents and disasters in all aspects of its activities, from exploration to sales.

Approach to Safe Operations

When accidents and disasters occur, they may have a serious impact on local communities and corporate performance. The NOC Group believes that "ensuring safety is basic to the management of its activities." Based on this awareness, the Group is constantly working to improve its safety measures. Under the NOC Group Environment & Safety Committee, a Safety Subcommittee has been established with the mission of constantly going through the Plan-Do-Check-Action cycle on a continuing basis to attain safety in all aspects of operations, from exploration to sales.

Preventing Accidents and Disasters

In FY 2005, the Group established priorities by divisions, from refining to oil depots and distribution (trucks and tankers), and implemented safety initiatives to prevent accidents and disasters. In FY 2006, plans call for focusing on taking these priority safety targets further in comparison with the previous fiscal year and carrying out safety management activities on a continuing basis.

Priority Policies in FY 2005

Refineries

- (1) Strengthening autonomous self-safety management
 - Carrying out reliable equipment maintenance management
 - Promoting additional safety measures to prevent similar accidents
 - Enhancing safety training
- (2) Structuring risk management system
 - Conducting reliable MOC (management of change)
 - Making process risk assessment mandatory
 - Enhancing crisis management
- (3) Stamping out labor accidents
 - Introduction of labor accident index and implementation of target-oriented management
 - Enhancing safety guidance provided to partner companies

Oil depots

- (1) Strengthening safety management
- (2) Enhancing supervision of equipment maintenance management

Tankers

- (1) Upgrading activities of safety promotion personnel
- (2) Revitalizing safety committee for coastal shipping
- (3) Making meetings before work mandatory

Trucks

- (1) Expanding safety training activities
- (2) Upgrading the role of roll call
- (3) Eliminating driving claims

Conducting Media Training

When accidents and disasters occur, providing correct information to stakeholders and implementing appropriate public relations activities are essential. To improve capabilities for responding to changing conditions at the time of accidents, NPRC periodically conducts real-time communications practice sessions (media training) at its seven refineries.

In these training sessions, participants assume that an accident has occurred, and employees play the role of media reporters, local residents, and other interested parties. Communications personnel respond to questions via telephone and conduct press conferences. As follow-up to these practice sessions, communications personnel identify problems and suggest ways to improve their responses.

<Media training at the Negishi Refinery>



Accident response headquarters during a crisis drill



Fact-finding to obtain the true story

Working to Ensure Safety through Guidance and Training for Truck Drivers

By **Mankichi Hagiwara**, Leader of the Safety Guidance Team, Kanto Branch of ENEX Co., Ltd.

At ENEX, heads of safety guidance, like myself, are appointed from among truck drivers. The main roles of head of safety guidance are to provide guidance and training relating safe operations and driving to new employees and less experienced personnel.

Through practical training in loading and unloading trucks, we work to give drivers improved safety consciousness and make sure that they will carry out their work correctly and without fail.

Also, we work to give them guidance and make them understand fully that a truck with the ENEOS trademark is a moving advertisement for the NOC Group, and that each and every driver is responsible for and represents the ENEOS brand. This means they must have good driving manners at all times, including observing legal speed limits strictly.

To stamp out problems like putting the wrong type of fuel in service station tanks, spilling petroleum products, or making deliveries to the wrong service stations, we hold meetings at the beginning and end of each working day to call the roll and share information on any problems that arose during the day and to call on everyone to take proper care. We also call meetings of team leaders and team members to work toward preventing operating problems.



Preparing for Possible Accidents and Disasters

Along with day-to-day safety promotion activities, the NOC Group takes a full range of measures, including equipping its refineries and oil depots, with various types of fire prevention and control systems in preparation for the possibility of accidents and disasters.

Disaster Prevention Equipment

To prevent spilling of petroleum products, storage tanks are surrounded by several walls to keep gasoline or other products from flowing outside the oil depots. In addition, in cases where petroleum products are stored on ships, the vessels are surrounded by oil fences, and oil recovery vessels are kept in readiness to take quick remedial action when necessary ready.



Practice drill for deploying an oil fence to prevent water pollution from oil spills

To put out fires, ample equipment for spraying extinguishing foam and water is kept ready, along with chemical fire trucks, aerial water cannon trucks, foam liquid transport trucks, and high-performance foam extinguishing systems. In addition, to deal with accidents and disasters on the water, the NOC Group keeps fire-fighting vessels ready.



Various types of fire-fighting equipment

Disaster Drills and Training

To deal quickly and effectively with accidents or disasters if they occur, the NOC Group has formed an internal organization to deal with fires and other contingencies and conducts comprehensive training exercises. In addition, the wide range of related types of training conducted by the Group include practice in shutting down machinery and equipment in the workplace, training for sounding warning signals, and fire-fighting exercises



Comprehensive training exercise for disaster prevention at the Negishi Refinery

Occurrence of Labor Accidents

Data on labor accidents at the Group's refineries are shown in the tables below. The number of such accidents has been stable in recent years, and further efforts are under way to eliminate them.

As part of activities to prevent labor accidents, the Group is taking steps to install full body harnesses for personnel engaged in filling tank trucks to prevent them from falling from the vehicle. Plans call for installing these accident prevention harnesses at all the Group's refineries and oil depots in Japan.



Personnel using full body harnesses when loading petroleum products into tank trucks

Number of Labor Accidents (NPRC)

	Injury with lost work days	Injury without lost work days
FY 2003	1	10
FY 2004	2	13
FY 2005	1	9

Ratios Indicating Frequency*1 and Severity*2 of Accidents (NPRC)

	Frequency	Severity
FY 2003	0.20	0.002
FY 2004	0.39	0.003
FY 2005	0.21	0.001

Note: Calculation year was changed from calendar year to fiscal year from this report.

Supplementary Information: Frequency and Severity Ratios by Industry

	All Industries		Chemical Industry		Petroleum Refining Industry	
	Frequency ratio	Severity ratio	Frequency ratio	Severity ratio	Frequency ratio	Severity ratio
FY 2003	1.77	0.12	0.83	0.07	0.42	0.02
FY 2004	1.78	0.12	0.92	0.07	0.24	0.004

Sources: Ministry of Health, Labor and Welfare, *Labor Accident Survey*; For petroleum refining, statistics are from the *Labor Survey* issued by the Petroleum Association of Japan.

*1 This ratio indicates the frequency rate of lost-worktime injuries and illnesses as a result of labor accidents for every one million hours worked.

*2 This ratio indicates the seriousness of labor accidents that occur.

Social Contributions

As a corporate citizen, the NOC Group views its ties with society as being of the utmost importance and proactively undertakes a range of activities to contribute to the betterment of society.

Initiatives for Social Contributions

Over the years, the NOC Group has conducted many types of activities to contribute to society both in Japan and overseas. To further expand and deepen the significance of these activities, the Group has adopted its Basic Policy for Social Contribution Activities, and, in April 2005, established its Community Engagement Office. Moreover, in June 2005, accompanying expansion in the Group's corporate social responsibility (CSR) promotion system, the NOC Group Community Engagement Committee was formed under the CSR Committee, to promote social contribution activities.

Basic Policy for Social Contribution Activities

1. The NOC Group works to achieve environmental harmony. The Group also values highly its ties with all its stakeholders and seeks to contribute to making a better, more pleasant lifestyle for everyone.
2. The NOC Group actively pursues activities that make society better and more livable with the principal themes of "environment and energy" and "contribution to the community," while also supporting the voluntary activities of employees that contribute to society.
3. The NOC Group continues to contribute to society and aims to be the comprehensive energy company winning the maximum support from the general public.

Comment by **Akira Suzuki**, Senior Staff of the Community Engagement Office, General Administration Department, Corporate Management Division II of NOC

"Three years ago, I participated in the "Japan and UAE Friendship Exhibition," which was held in Abu Dhabi, to explain the business activities of NOC. (Please see photograph below.) When the local people attending the exhibition saw a model of a fuel cell begin to generate electricity when hydrogen was injected, their eyes widened and they exclaimed "how nice!" and "magic!" This moving experience was the origin of my own social contribution activities. My goal going forward is to plan social contribution activities that are appropriate to the NOC Group and are related to environmentally-friendly energy."



Activities Contributing to the Environment

The NOC Group, as a comprehensive energy company, gives full consideration to the impact that energy consumption has on the environment and is engaged in many initiatives to contribute to society through environment and energy related activities.

● Creating "ENEOS Forests"

"ENEOS Forests" are being established as part of a joint program that allows us to form partnerships with regional governments and the National Land Afforestation Promotion Organization to preserve specified natural forest areas. The areas supported by the NOC Group are being named "ENEOS Forests" and will be located primarily in the vicinity of the Group's oil refineries. One of these forests established in FY 2005 is located in Kanagawa Prefecture, and, in FY 2006 plans call for creating another five such areas. The NOC Group is focusing especially on the many important roles of forestlands, including the absorption and storage of CO₂ as well as the preservation of biodiversity, and is planning to work actively to help preserve forest resources.



● Donation of ENEOS Card Proceeds to the National Land Afforestation Promotion Organization (NLAPO)

Since we began issuing ENEOS Cards in October 2001, 0.01% of the amount that our customers charge to their ENEOS cards at ENEOS service stations has been donated to the NLAPO to support that organization's environment-related activities in Japan and in other parts of the world. Accumulated contributions have reached 50 million yen.



● Environmental Education Activities

Working in cooperation with the Junior Eco Club (sponsored by Japan's Ministry of the Environment), the NOC Group is scheduled to present environmental education sessions to Eco Club members at its six refineries in Japan beginning in July 2005. The objective of these activities is to provide explanations that are easy to understand, fun, and help participants to learn about the environment and energy. (Prior to this series, an environmental education session was held at the Group's Osaka Refinery in FY 2005.)



● **“ENEOS Children’s Science Classes”**

In January and February 2005, we presented a session entitled “ENEOS Children’s Science Classes” for children living in the vicinity of the Central Technical Research Laboratory for three days. The classes offered the opportunity for children to study with a lot of fun conducted with models, including one demonstrating the operation of fuel cells.



● **Participation in “Tokyo Greenship Action”**

“Tokyo Greenship Action” is a program aimed at helping to preserve the natural environment and is sponsored by the Tokyo Metropolitan Government, corporations, nonprofit organizations (NPOs), and other groups. We began to participate in this program in November 2004. Its activities include restoring rice fields as part of programs to preserve villages and mountainous areas in the Zushi-Onoji Historical Environment Conservation Area in the vicinity of Machida City outside Tokyo. Restoration of the fields is being conducted by NOC Group volunteers using traditional farming methods, under the direction of the Machida Rekikan-Kanri-Kumiai.

Comment by **Mr. Koichi Tagoku**, Chief Director of Machida Rekikan-Kanri-Kumiai
 “We are transmitting our knowledge and skills to corporate volunteers and would like for them to use it to contribute to the environment.”



Mr. Tagoku (right) giving instruction



Comment by **Ms. Emi Shimoya**, Senior Staff Member, Greenery Environment Section, Natural Environment Division, Bureau of Environment, Tokyo Metropolitan Government

“Activities that contribute to the natural environment arranged in partnership by corporations, NPOs, and government groups make it possible for many interests to become involved in preserving the natural environment. This is a

new way of helping to preserve the environment and I believe it will be quite effective. Now that the NOC Group has begun to participate in these new activities, we would like the Group to continue and take part in many kinds of programs that contribute to the environment.”

Activities Contributing to the Community

The NOC Group places a high value on its ties between the local communities served by its network of about 11,000 service stations and its branches, refineries, and overseas offices and is working actively to contribute to regional communities.

● **Inviting 1,800 Children to the “FC Tokyo” Home Game**

NOC is the main sponsor supporting the FC Tokyo J-League soccer team and sponsors “ENEOS Friend-Crew Seats” at home games on a regular basis. Working with the Japan National Council of Social Welfare, we invite 100 children from care facilities to each of the 18 home games.



Testimonials from children

● **“ENEOS Baseball Workshop”**

Beginning in 1997, current and former players on the NOC baseball team hold the “ENEOS Baseball Workshop.” In FY 2005, 31 teams with 430 primary and junior high school aged members participated in the workshop.



● **“ENEOS Get-Together Festival”**

In August 2004, the NOC Group held “ENEOS Get-Together Festival” at its Sendai Refinery, which drew more than 1,100 participants from the surrounding area. Activities included opportunities to ride in tank trucks and fire trucks, which attracted children attending the festival.



Support for Employees' Voluntary Social Contribution Activities

The NOC Group provides support for employees who engage in activities to contribute to the community. In FY 2005, in response to inquiries from employees who stated they were interested in volunteer programs but did not know how to join in these activities, we made arrangements to make participation in volunteer programs easier.

● Training Program for “Environmental Volunteer Leaders”

Beginning in FY 2005, we began offering a training program for “environmental volunteer leaders” focused on obtaining experience and practical training in forest preservation activities. This program is intended to raise the level of awareness of environmental issues among employees and train personnel who can participate actively in environmental volunteer programs. Beginning in FY 2006, plans call for the holding of these training programs four times a year for groups of 20 participants for each program.



● Offering Opportunities for Volunteers

To enhance the awareness of employees, in FY 2005, we planned and sponsored volunteer activities related to forest preservation that drew a total of 104 participants during the year.

Emergency Disaster Support

The NOC Group provided financial support following the Niigata Chuetsu Earthquake, the Indonesia Sumatra Offshore Earthquake, and the Fukuoka Western Offshore Earthquake. At the time of the Niigata Chuetsu Earthquake, we also provided emergency supplies support, including kerosene supplies; dispatched service station personnel to disaster areas; and provided personnel support for fueling operations.



International Cooperation

Strengthening friendly and cooperative relationships with oil-producing countries is important for Japan because of its lack of petroleum resources. As part of activities to bolster these ties, the NOC Group implements many types of support projects for oil-producing countries.

● Social Contribution Activities in Vietnam

The NOC Group is producing crude oil in the Rang Dong oil field offshore the southern part of Vietnam, and, to provide assistance that contributes to the local community, the Group has made donations for constructing primary schools and conducted other social contribution activities. In FY 2006, we provided a grant for construction of a rehabilitation facility for physically challenged children.



Ground-breaking ceremony for the rehabilitation facility

● Overseas Technical Cooperation Projects

Technical cooperation projects related to the prevention of global warming and other environmental and energy related areas are as follows:

- Saudi Arabia: Hydrocracking technology
- Iran: Technology for producing low-sulfur diesel fuel
- Indonesia: Electric power generation technology for oil refineries

● Acceptance of Trainees and Sending of Specialists

These activities include acceptance of trainees from oil-producing countries and the Asian region and dispatching of specialists to assist in various areas. Through technological exchanges involving the interchange of persons, the NOC Group contributes to building stronger ties with these countries and regions.

- Trainees: India, China, and Vietnam (a total of 76 in FY 2005)
- Sending of specialists: Iran, India, Indonesia, Kazakhstan, and China (a total of 17 in FY 2005)



Trainees touring the Negishi Refinery

Respect for Human Rights and Dignity

The NOC Group is emphasizing development of personnel systems, training, and self-development with the objective of creating a workplace that enables all employees to work energetically and to the best of their abilities.

Initiatives to Respect for Human Rights and Dignity

The NOC Group has positioned respect for human rights and dignity as a CSR focus area. In June 2005, we newly established the NOC Group Human Rights Committee under the NOC Group CSR Committee. The initiatives of the Committee will focus on promoting employee capabilities, supporting women's success, enlightenment of human rights, and promoting support for the physically challenged.

To achieve the goals of the Third Medium-Term Consolidated Management Plan, which we began to implement in April 2005, it will be essential to further develop the capabilities of employees, who must take a leading role in carrying out the plan, and encourage them to draw fully on their skills and abilities. Thus far, we have taken "training and motivating human resources" as our objective and have moved forward with reforms of our personnel system, including compensation and evaluation practices.

In FY 2006, we are taking further steps to improve our human resources development systems and are working to enable each and every employee to show his/her individual and abilities to the fullest and create a corporate culture and atmosphere that encourages employees to work energetically and positively.

Promoting Employee Capabilities

Systems for Compensation, Evaluation, and Personnel Transfer

The basic concepts of the NOC Group personnel systems that aim to nurture and invigorate its human resources are as follows.

1. Reflect the most recent results (the employee's present value) in employment conditions

To motivate employees and encourage them to be proactive, we must evaluate the results achieved by each employee and reflect this in benefits and compensation in a timely way. Based on this concept, we have reformed our existing compensation, evaluation, and retirement benefit systems accordingly.

2. Enhance transparency, fairness, and satisfaction of personnel evaluation systems

Our compensation and evaluation systems are "accomplishments oriented" but in order to make these systems function properly, it is important that the evaluation systems be transparent, fair, and satisfied. To make these systems operate in the manner intended, we are conducting a continuing program of "evaluation training" for middle management who occupy a vital position in the operation of the evaluation system. They should provide appropriate feedback on evaluation results to each and every employee.

3. Provide opportunities for employees to make full use of their abilities

Along with revisions in the compensation and evaluation systems, we are working to offer all employees new opportunities to show their capabilities and become more motivated to work energetically by making the following changes in the personnel transfer systems.

● Entry System

Under this system, when employees have a strong desire and clear reasons for being assigned to certain jobs, whenever possible, they are assigned in accord with their requests. In FY 2005, close to 100 requests for specific positions were received, and, in 40% of the cases, the new assignments of these employees reflected their requests.

● Internal Recruitment System

This system makes it possible for the Company to call for volunteers among employees for work in new business fields and projects. In FY 2005, we called for applications from employees for three such projects, and, in each case, the number of applicants exceeded the number of positions. This system is helping to increase employee motivation and work commitment.

Recruitment

In recruiting new employees, we make information on the type of human resources we are looking for and the fields where they will work available on our Website and through other media, thus providing information fairly to everyone wanting to apply for positions.

In the process of selection, we place emphasis on the objectives and desires of prospective employees and employ the same selection processes for all potential employees regardless of gender or other characteristics.

Overall Outline of the Personnel System

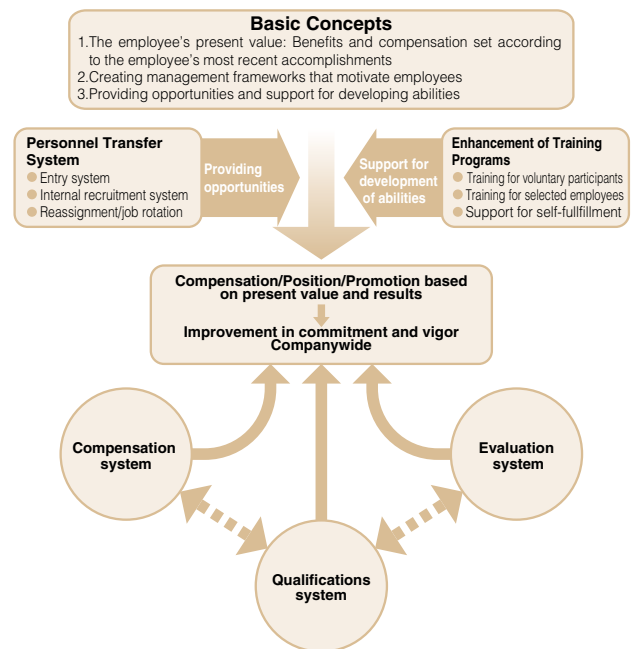

Human Resource Development

The NOC Group has had three types of human resource training thus far, namely, on-the-job training through experience in the workplace, off-the-job training, and self-fulfillment training. Our efforts are now directed at upgrading these three forms of human resource development while respecting the identity of employees.

These three types of human resource training are mutually complementary. For example, the objective evaluations that employees receive from external instructors in graduated training programs, which are a form of off-the-job training, and the evaluations of their abilities that they receive from on-the-job training activities help them to understand their own abilities. Based on this understanding, employees can make arrangements to improve their abilities on their own through programs they undertake on their initiative and other self-fulfillment activities. To provide guidelines for these employee initiatives, we provide examples of the "behavior and thinking that is expected of employees" in various job positions on the intranet.

New forms of training include "training focused on items in the Medium-Term Consolidated Management Plan," which is intended to support attainment of the plan's goals, and "departmental training courses," which are aiming at transmitting knowledge and know-how to the next generation.

In addition to the above-mentioned programs, which are aimed at enhancing the abilities of all employees, there are also human resources programs provided for selected individuals who are being groomed to play leadership roles in the organization at an early stage.



Group discussion during training sessions for new employees

Sanitary and Mental Health Issues

To enable employees to go about their work energetically, health issues are a major point.

The percentage of employees receiving periodic health check-ups offered by NOC is almost 100%. In addition, NOC also offers a program of health and sanitary policies tailored to individual needs, including information on preventing health problems related to lifestyles and a telephone health advisory service.

Among these programs, we believe that special focus on mental health issues is warranted. We have distributed a pamphlet on mental health to all employees, and the NOC health insurance union offers advisory services via telephone.

Outline of Training Programs

	New employees	← Management-level	
Graduated training	Training for new employees	Training by job grade (implemented when employees are promoted)	
Training for evaluators			Evaluation training
Training for core employees		Training for business leader	Training for selected employees Training for management-level employees
Training for voluntary participants	Open seminars (Negotiation skills / Marketing/Quantitative supervision)		Training for selected management-level employees
Training in topics related to medium-term management plan	Training in topics related to the medium-term plan		
Training by division/department	Departmental training (implemented by division)		
Overseas training	Study overseas (MBA, etc.), live-in training in Japan (business schools) Short-term overseas courses Practical training at companies overseas		
Sending to external posts	Seminars for interchange with other industries, training outside the Company		
Language training, self-fulfillment	International Communication School (Intensive English-language training)	Language training (training for TOEIC exams/English/Chinese) Support for self-fulfillment (encouragement of correspondence course training)	

Supporting Women's Success

The NOC Group believes supporting women's success will contribute to overall vitality and motivation and lead to further corporate growth going forward.

In line with the content of the Law for Promoting Policies to Nurture the Next Generation, in April 2005, we set an objective for providing for leaves of absence for child rearing. To achieve this goal, we are working toward creating an office environment that will make it easy for both female and male employees to take leaves of absence for child rearing as well as vacation days for this purpose.

In addition, along with measures to expand the recruitment of female employees and proactively assign them to suitable positions, we are continuing our initiatives to prevent sexual harassment and eliminate gender consciousness. The ultimate aim of these activities is to promote the creation of a working environment where women can perform to the best of their abilities.

Enlightenment of Human Rights

Respect for human rights and dignity is a fundamental part of production and other aspects of business activities. We believe it is important for all management and employees to make business judgements, act, and make statements based on an understanding of human rights. To this end, graduated training programs from a variety of perspectives are provided for new employees, middle-level personnel, management personnel, directors, and other classes of employees with the aim of promoting the proper consciousness and understanding of human rights.

For example, to promote the understanding that working together with all kinds of persons—including senior citizens, physically challenged individuals, and others in the home, region, school, workplace, and other situations—is part of the normal course of events, we invite sign language instructors to our human rights training courses. These instructors can speak from the perspective of persons with physical disabilities and give participants in the courses the opportunity to experience sign language in practice.



Members in the normalization session experienced sign language

In addition, we have established the NOC Group Human Rights Enlightenment Committee and have formed a special committee to exchange information on human rights enlightenment among 19 companies of the NOC Group.

Every year during Human Rights Week in December, we ask management and employees of the Group companies to submit slogans related to human rights and use these activities as an opportunity for heightening awareness of human rights. Every year, we receive about 2,000 suggested slogans and then select the best entries to receive awards and publicize these to management and employees. Especially during FY 2005, the following slogan received an award for excellence and won a prize in the human rights slogan contest sponsored by the Tokyo Human Rights Enlightenment Corporate Liaison Committee.

**“Begin with what we can do.
Everyone has a leading role to play in protecting human rights.”**

Submitted by the family of Minoru Umayahara, employee at Mizushima Refinery, NPRC.

The NOC Group is committed to placing a high priority on human rights and will continue to conduct a wide range of training and other activities to encourage respect for humanity.

Promoting Support of the Physically Challenged

Of the 19 companies in the NOC Group, 12 have a legal obligation for employing a specified percentage of physically challenged persons. NOC set a goal of attaining employment of persons in this category of 2%, compared with a legal requirement of 1.8%, but had actually attained 2.1% as of June 1, 2005.

In addition to providing employment, the NOC Group companies provide the services of advisors to assist physically challenged employees not only in their working activities but also their daily lives. In addition, we are working to provide other assistance, including the installation of restrooms and elevators for persons in wheelchairs at NOC’s Headquarters.

The NOC Group as a whole intends to continue to recruit physically challenged persons and provide an environment where they can work with peace of mind in bright and pleasant surroundings.

Physically Challenged Employees of the NOC Group

(Number of points* as of June 1, 2005)

	Number employed	Number legally required
Nippon Oil Corporation	61	51
Nippon Petroleum Refining	59	44
Nippon Petrochemical	23	20
Nippon Oil Exploration	1	1
Nippon Oil Staging Terminal	5	2
Nippon Oil Real Estate	1	1
Nippon Oil Trading	7	5
Nippon Petroleum Processing	4	3
Nippon Petroleum Gas	5	4
Nihonkai Oil	2	2
NIPPO Corporation	72	70
Wakayama Petroleum Refining	1	1

*A severe physically challenged person is counted double.

Activities of the NOC Introduced

Fourteen companies, including NOC, were introduced in *Promoting Employment of the Physically Challenged: Good Examples by Industry*, published by the Tokyo Association for the Promotion of Employment of Physically Challenged Persons. NOC examples introduced included the sponsorship of sign language courses, installation of welfare facilities, and good examples of employment provided for hearing- and speech-impaired persons.



Stakeholder Comments

Opinions and suggestions received from stakeholders will be reflected in the CSR activities of the NOC Group.

Initiatives Related to Opinions and Suggestions Received

Opinions and Suggestions Received in FY 2005

I hope to see an increase in communications at service stations, and I look forward to a report on the service stations in the next report.

Initiatives of the NOC Group

We distributed the summary version of *Sustainability Report 2004* at some service stations, and introduced not only the development and supply of sulfur-free gasoline and diesel fuel but our initiatives toward an energy society in the future. In this report, we report "CSR Initiatives at Service Stations" (Pages15-16).

The environmental vision for attaining environmental harmony and creating a sustainable society into the future is easy to understand and gives us a clear idea of the direction the NOC Group is moving.

The earth's environment is steadily deteriorating because of our lifestyles. As the integrated evaluation of the environmental impact on page 21 shows, the effect of petroleum products is by far the greatest at the consumption stage. From this, we can see that we must have a better awareness of the significance of energy usage. The points are what energy sources we choose and how we use energy.

Last year, I mentioned the issue that communication at service stations, which are the point of interface with us, is important. As a result, I received a report that you distributed a summary version of your *Sustainability Report 2004* at service stations this year, and I was very impressed by how quickly you took action. The report on initiatives at your service stations is easy to understand. Looking forward, measures for volatile organic compounds (VOC) at your service stations will be an issue. Also, just providing information for customers on usage and other aspects of how to save energy is very effective. I want you to continue to provide carefully tailored information at your service stations that will help us to change our lifestyles.

Ms. Kikuko Tatsumi

Board member
Chairperson of the Environmental Committee
Nippon Association of Consumer Specialists



Opinions and Suggestions Received in FY 2005

It will be important for employees and customers to take part in jointly promoting social contributions and systems building that are in keeping with the Company's policies.

Initiatives of the NOC Group

We actively develop social contribution activities with the important fields of "environment and energy", "contribution to the community", and "support of the employees' voluntary social contribution activities" (Pages31-33).

As we move toward a sustainable society, each and every one of us has an urgent responsibility to show concern for the natural environment. In your activities as a comprehensive energy company aimed at contributing to society, you have made clear and specified your intentions to focus especially on "environment and energy," "contribution to the community," and "support of the employees' voluntary social contribution activity." I believe you have also pointed out your responsibilities as a corporation and made clear your stance and direction as regards expanding these activities to local and individual levels.

Going forward, to really put CSR into action, it will be important to extend and share these activities, first with all members of the Group, to your dealerships and sales companies, and all along the supply chain. You should take particular note that ENEOS service stations are viewed as representing the NOC Group by the communities you serve. The roles they play in times of disasters and emergencies are major, and you have considered this in your business policies. However, for these roles to come alive, building community relationships day-by-day is important. Most importantly, the summation of these daily initiatives will help build confidence in the Group and, I believe, will lead to consolidating your brand position and brand promise. I expect that you are pleased to be engaging in Group CSR activities that will be leading to emotional bonding and cooperative efforts with your customers and other stakeholders.

Ms. Yoko Takahashi

Chief Director
Japan Philanthropic Association



	Opinions and suggestions	Related initiatives of the NOC Group
Stakeholder comments	<p>"I look forward to specific paths for attaining the sustainable society and specific results each year, backed by objective data." Mr. Takeshi Mizuguchi, Assistant Professor, Takasaki City University of Economics</p>	The NOC Group is working to promote environmental management covering 19 Group companies and to offer quantitative information from exploration through the consumption stages in the section "Integrated Evaluation of Environmental Impact" (Pages 19-21), with the aim of using this information to reduce the environmental impact on a continuing basis.
	<p>"I would like to hear about your R&D and measures to increase the usage of natural energy." Mr. Kenro Taura, General Secretary, Kiko Network, an NGO</p>	NOC is already operating a wind power generation business at its Akita Oil Depot (Page 25) and is planning to expand these operations. In addition, the NOC Group is actively engaged in R&D to make use of natural energy sources.
Reader survey	<p>"If accidents or other troubles emerge, we would like you to disclose related information."</p>	The section on page 10 contains information on accidents and troubles as well as measures to prevent recurrences of such incidents.
	<p>"Please disclose information on goals and accomplishments related to items other than the environmental activities."</p>	To the greatest extent possible, we will present information on goals and results and work to make the presentation clear and easy to understand. In addition, we will make ample use of charts and graphs to make the presentation visually appealing.

Items to Be Reported on a Continuing Basis

There were certain items covered in the *Sustainability Report 2004* that could not be included in this year's report for reasons of editorial policy and space. For continuity, progress on the following principal initiatives will be covered henceforth on a continuing basis.

Area	Content	Pages of the 2004 report	Progress to date
Disclosure of environmental information	Disclosure of environmental accounting information	25-28	Detailed information will be available on the NOC Website in October 2005 (in Japanese only).
	Time series data on atmospheric, water quality, and pollutant release and transfer register (PRTR)	40-41	
Environmentally-friendly products	Development and promotion of environmentally-friendly products (Industrial lubricant series, automobile lubricant series, and other products for specific functions)	31-32	Listed as an important theme in the Medium-Term Environmental Management Plan for FY 2006 to 2008 and we will work on them with continuing attention
Contributions to the recycling-based society	Expansion of recycling business activities (investment in Mizushima Ecoworks Co., Ltd., and other activities)	35-36	The waste recycling facility of Mizushima Ecoworks went into operation in April 2005.
Environmental activities across all businesses	Environmental consideration in exploration and development of oil and natural gas, upgrading of HSE and MS ^{*1}	39	Initiatives continuing with highest priority on policies that contribute to ensuring safety for human life
	Prevention of ocean pollution in crude oil transportation (Prevention of disturbances to the natural habitat by ballast water ^{*2} , use of alternatives to ship paints containing endocrine disrupting chemicals ^{*3})	39	Continuing implementation of policies contributing to preservation of the natural habitat
	Steps taken to reduce emissions of benzene and hydrocarbon carbide (HC)	41	Continuing implementation of policies for reducing emissions

*1 Occupational Health, Safety and Environment Management Systems

*2 Seawater pumped into empty tankers as ballast to ensure safe sailing *3 Use of zinc-based paints in place of tributyltin, which is suspected of being an endocrine-disrupting chemical

Relationships with Stakeholders

The NOC Group works to maintain good relationships through communication with all its stakeholders.

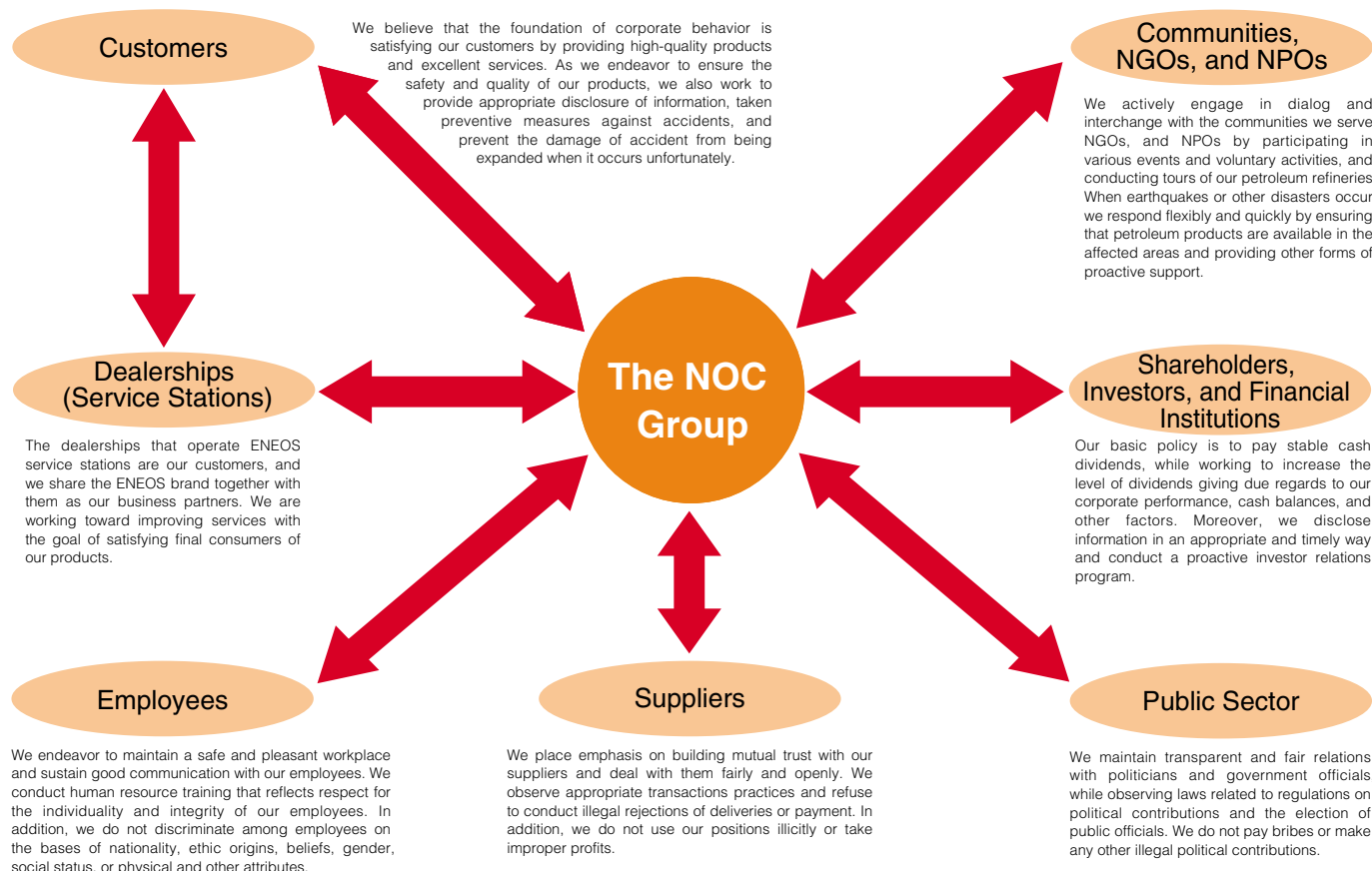

Allocation of “Value Added” Generated by Our Business Activities to Stakeholders

The NOC Group has prepared a trial calculation of how the value added generated by the Group is allocated to various stakeholder groups for illustrating social relationships between the NOC Group and its stakeholders.

Allocation of Value Added to Stakeholders (FY 2005)

	Stakeholder	Billion yen
1. Source of value added generated by business activities (Net sales, etc.)	Customers	4,970.7
2. Payments to suppliers	Suppliers	4,571.2
3. Value added generated by the NOC Group (1-2)		399.5

The total amount of various taxes on gasoline and diesel fuel paid by NOC, 1,022.2 billion yen*, is including its payments to suppliers.

*A part of payments to other oil companies and trading companies, etc., is included in the total amount of our tax during FY 2005. Then, the total amount of our tax is estimated to be 697.1 billion yen in the same calculation method as FY 2005.

Notes: Companies included in the value added calculation and items in the computation

1. Companies included: The above indicators are based on data for NOC and its consolidated subsidiaries plus three other companies (Shibushi Oil Storage Co., Ltd., Kamigoto Oil Storage Co., Ltd., Nippon Oil Research Institute Co., Ltd.) for a total of 19 companies. The ratio of the sales of the 16 companies is approximately 90% of all companies on the consolidated financial statements.
2. Items in the computation: Items from the financial statements of NOC and its consolidated subsidiaries plus three other companies used in the compilation of this data were recurring income (based on net sales; cost of sales; selling, general and administrative expenses; non-operating income; and non-operating expenses); corporate income taxes, inhabitant's taxes, and the enterprise tax; and profit allocated (dividends and Board Members' bonuses).

Total value added: 399.5 billion yen

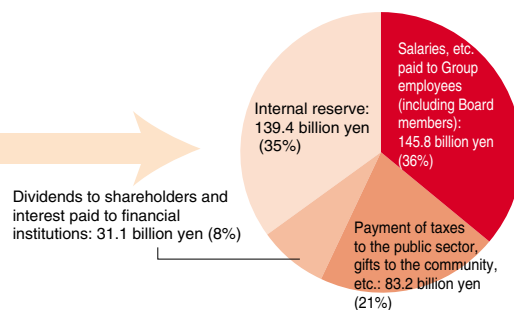

Independent Report

For the purpose of improving the accuracy and objectivity of this report, the NOC Group took third-party review by Tohatsu Environmental Research Institute, a member of Deloitte Touche Tohmatsu.

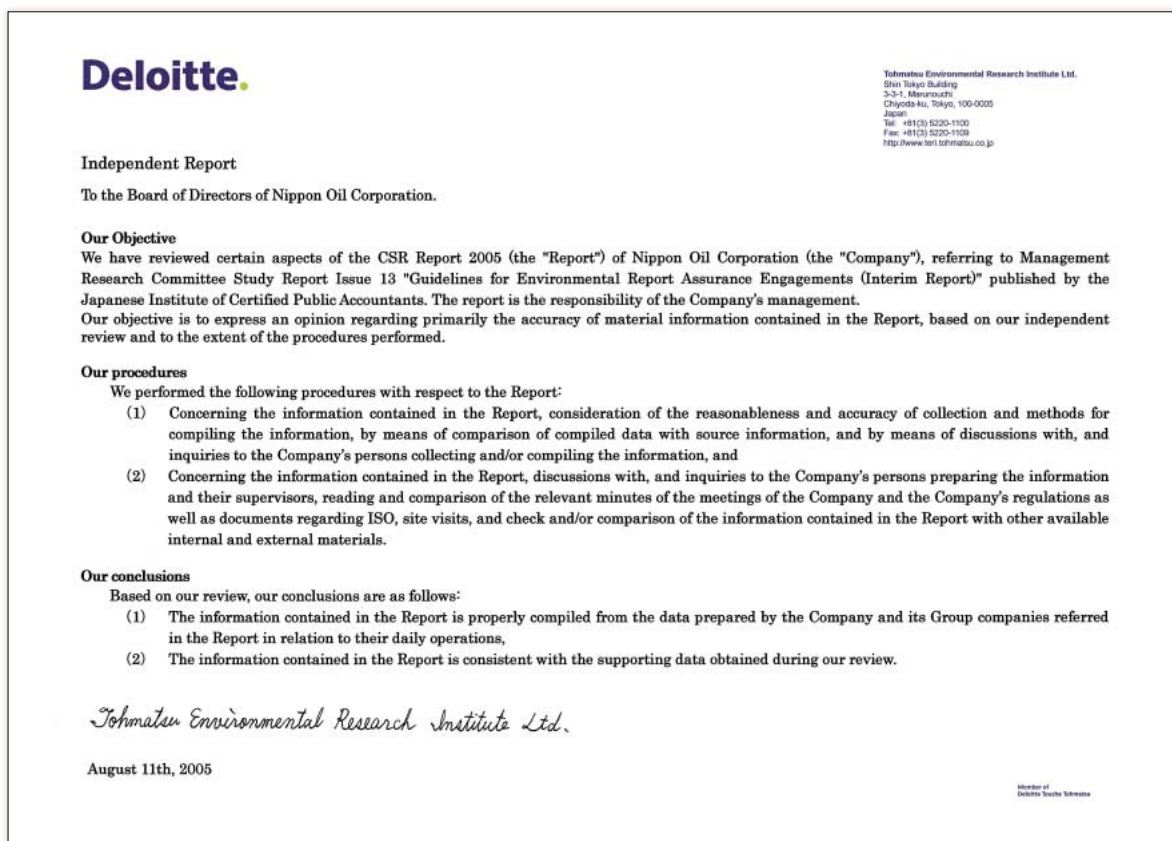

Independent Review Procedure

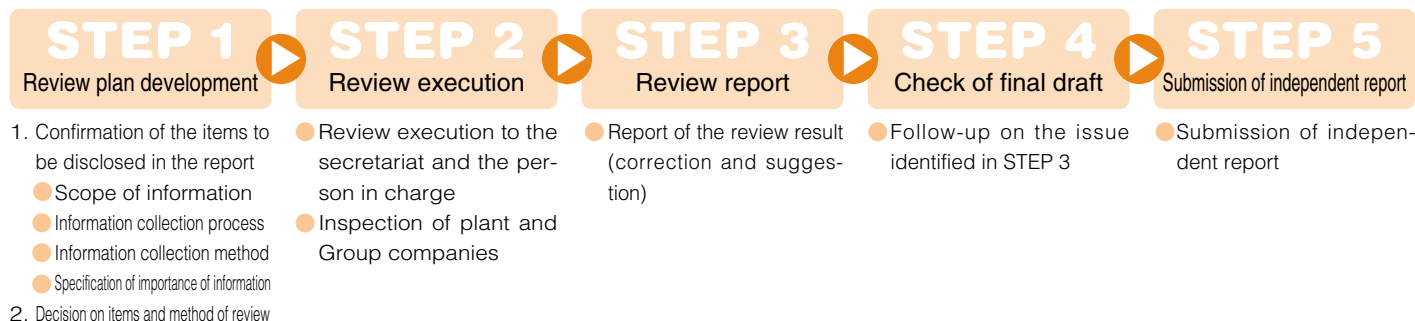

State of review

Supplementary explanation of sites visited

- Sites visited for the review: Nippon Oil Corporation (headquarters), Nippon Petroleum Refining Co., Ltd. (Sendai Refinery, Negishi Refinery, Osaka Refinery), Nihonkai Oil Co., Ltd. (Toyama Refinery), Nippon Petroleum Gas Co., Ltd. (Niigata Terminal), Shibushi Oil Storage Co., Ltd. (Shibushi Oil Storage Base)
- Sites were visited according to the rotation plan. Records of sites that were not visited were checked and reviewed at the NOC Headquarters.

NIPPON OIL CORPORATION

3-12, Nishi Shimbashi 1-chome, Minato-ku, Tokyo 105-8412, Japan
For inquiries

Environment and Safety Department

Phone: +81-3-3502-1128

Fax: +81-3-3502-9393



Printed in Japan

Questionnaire for Readers of the Nippon Oil Corporation Group *CSR Report 2005*

Question 1: What is your overall impression of this report?

- Very easy to understand Easy to understand Difficult to understand Very difficult to understand

(For those who read the NOC Group's *Sustainability Report 2004*)

Question 2: Compared to last year's *Sustainability Report 2004*, how would you assess this year's CSR Report?

- Very comprehensive Rather comprehensive No change from last year More difficult to understand

Question 3: Which sections of the report were of most interest to you? (Multiple answers)

- | | | |
|---|--|---|
| <input type="checkbox"/> Top Commitment | <input type="checkbox"/> Group Philosophy | <input type="checkbox"/> Medium-Term Consolidated Management Plan |
| <input type="checkbox"/> Corporate Governance | <input type="checkbox"/> Reinforcement of the CSR-oriented Management | <input type="checkbox"/> Compliance |
| <input type="checkbox"/> Information Security | <input type="checkbox"/> Assuring the Quality of Products and Services | <input type="checkbox"/> CSR Initiatives at Service Stations |
| <input type="checkbox"/> Environmental Management | <input type="checkbox"/> Medium-Term Environmental Management Plan | <input type="checkbox"/> Overview of the NOC Group's Environmental Impact |
| <input type="checkbox"/> Environmental Efficiency, Environmental Accounting | <input type="checkbox"/> Premium Gasoline | <input type="checkbox"/> Fuel Cells |
| <input type="checkbox"/> LNG, Wind Power and Cogeneration | <input type="checkbox"/> Global Warming Prevention Measures | <input type="checkbox"/> Surveys and Countermeasures for Soil Contamination |
| <input type="checkbox"/> Waste Reduction Measures | <input type="checkbox"/> Ensuring Safety | <input type="checkbox"/> Social Contributions |
| <input type="checkbox"/> Respect for Human Rights and Dignity | <input type="checkbox"/> Stakeholder Comments | <input type="checkbox"/> Relationships with Stakeholders |
| <input type="checkbox"/> Independent Report | | |

Question 4: Please give us your opinions regarding this report and the CSR activities of the NOC Group.

(Opinions)

Question 5: From what standpoint did you read the report?

- Customer Supplier or Other Business Partners Public Sector Corporation/Organization
 Group employee/Family member of a Group employees School/Educational Institution
 NGO/NPO Shareholder/Investor Survey/Research Institution Media
 Resident in a Community near an NOC Group office/facility Other ()

Thank you for your cooperation. Please feel free to give us your address and other information, if you wish.

Name	Gender	Age	E-mail address
Address and zip code			Telephone () Facsimile ()
Occupation (Place of work, school attended, etc.)			Would you like us to send next year's CSR report? Yes No

* Personal information you provide on this questionnaire will be kept in strictest confidence, in accordance with the NOC Group's privacy policy, and will be used only as reference for preparation of future NOC Group CSR reports. Under no circumstances will your information be disclosed or provided to third parties.

**Please send your completed questionnaire to Nippon Oil Corporation,
Environment, Safety & Quality Management Division Environment & Safety Department
3-12, Nishi Shimbashi 1-chome, Minato-ku, Tokyo, Japan 105-8412
Or by facsimile to 03-3502-9393 (In Japan) or +81-3-3502-9393 (From other countries)**